

U10 男雙

(7局制) 取前 8 名

取分組循環第一名進入單敗決賽，分組循環名次一經確認，立即由大會現場抽籤。

陳韋宇/李禾彥
(竹縣竹仁)

1

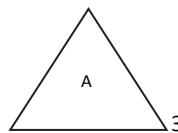

李洺豪/李旭清 周漢翔/簡町宇
(南市鹽水) (三和國小)

黃品叡/陳欣蕾
(南市新南)

10

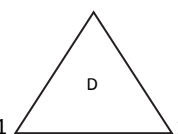

廖展毅/賴柏翔 許凱昕/鄭欣書
(鎮東國小) (東榮國小)

羅浩揚/何思盈
(竹縣竹仁)

19

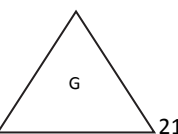

謝倫鎰/林柏宇 黃少鍊/董千豪
(竹市曙光/西門) (南市後壁)

簡宏諭/李坤林
(三和國小)

28

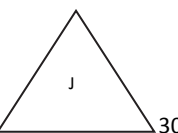

高子澄/張橙杰 張源家/賴禹辰
(鎮東國小) (大肚國小)

劉耀棋/何明哲
(南投前山)

37

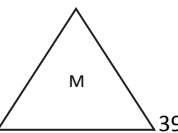

劉家睿/曾詮約 陳修水/胡宇晨
(鎮東國小) (竹縣竹仁)

鄭皓允/尤廷安
(竹市大庄)

46

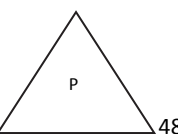

周愷軒/蔡慶文 賴品丞/賴奕崴
(雲縣荊桐/嘉縣三和) (竹縣中山)

黃煒宸/王宇亨
(竹縣竹仁)

4

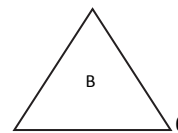

鍾子崴/鄭博隆 何軒鄂/沈昱勛
(雲縣溪洲) (屏縣麟洛)

沈著倫/胡彥丞
(鎮東國小)

13

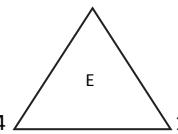

陳晷昀/許劭宇 陳昱志/方梓權
(竹市東門/西門) (南市港東)

蕭文強/高益威
(高市鼓山)

22

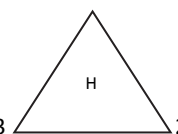

張祐盛/高瑋駿 林宗緯/翁浚淇
(鎮東/三和國小) (南市鹽水)

胡中宸/徐定揚
(南投碧峰)

31

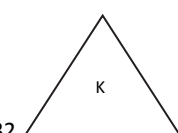

蕭紫宸/錢庭恩 許紹陽/李承真
(竹縣竹仁) (花縣鳳林)

吳永浚/楊士楨
(鎮東國小)

40

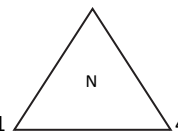

黃泳鍵/沈汎丞 徐翊展/郭柏佑
(南市後壁) (南市港東)

張辰安/石柏恩
(南市後壁)

49

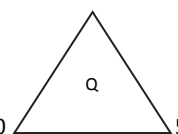

陳翔竣/梁孟愷 張宸碩/董建圻
(雲縣溪洲) (竹縣竹仁)

陳詠騰/馮一凡
(屏縣麟洛)

7

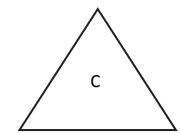

王以潔/徐宥丞 莊羽綸/馬韜
(南市港東) (竹縣竹仁)

戴靖哲/劉柏昊
(雲縣溪洲)

16

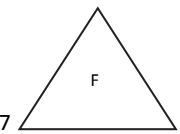

邱騰磊/張妍禎 楊萌樂/劉晉昊
(竹縣竹仁) (南市港東/南投新城)

林柏縵/郭庭璋
(南市新南)

25

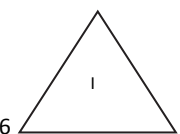

鐘紹齊/林鴻駿 王孝睿/陳宙芊
(雲縣荊桐) (中市忠明)

邱宸鑫/莊存洧
(南市後壁)

34

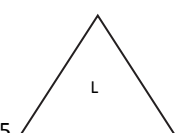

高上榮/林昇翰 邦昊恩/卓彥樟
(雲縣荊桐) (高市鼓山)

莊子諒/何沅叡
(南市後壁)

43

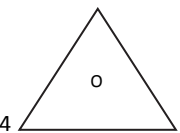

林宏駿/黃旗紳 賴煥棋/劉諺鴻
(花縣鳳林) (竹縣竹仁)

周宥頡/陳品翔
(竹縣竹仁)

52

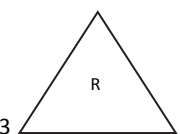

廖健澄/葉庭杰 曾翊帆/曾翊菲
(雲縣荊桐) (花縣明義)

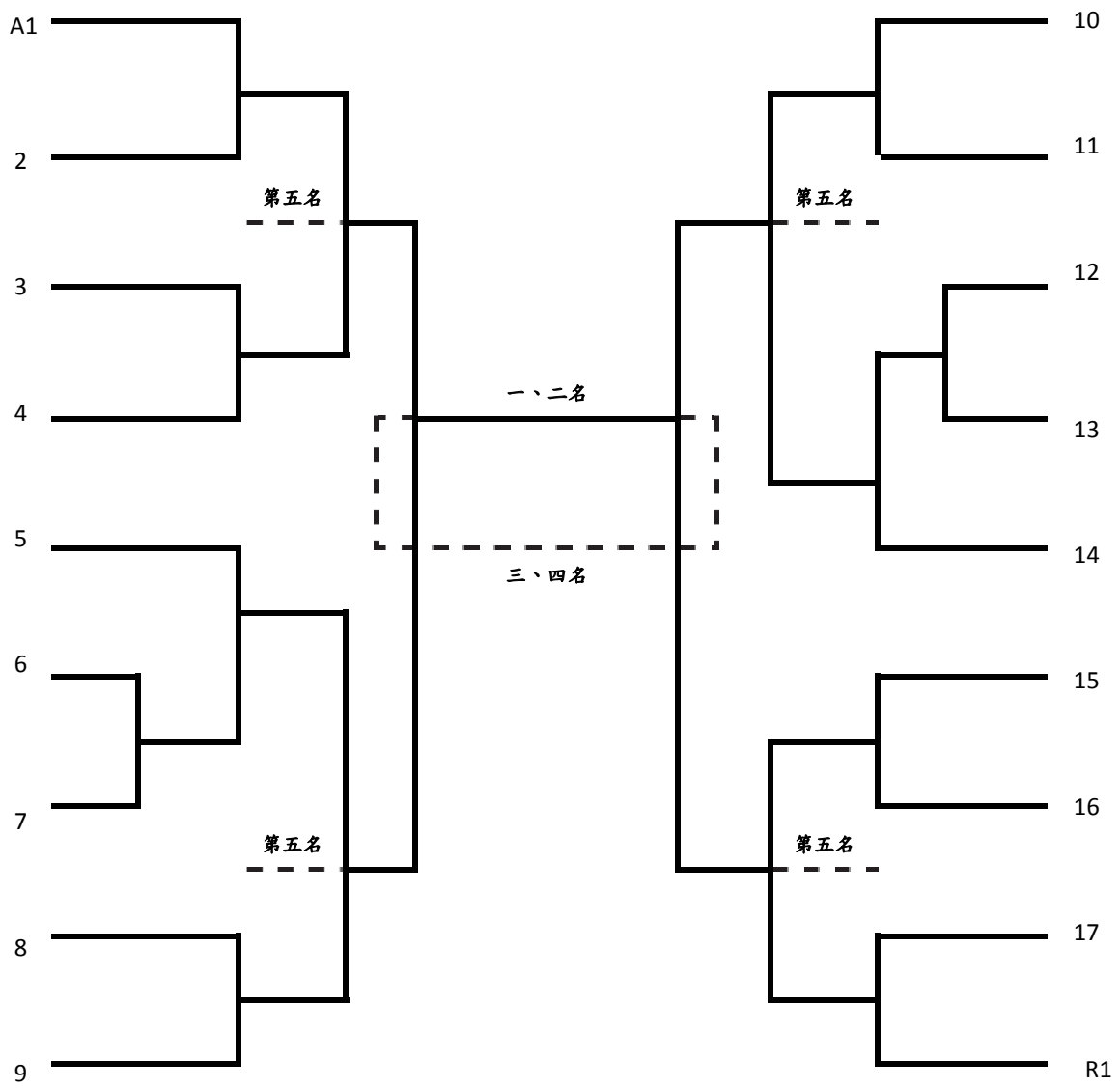

U10 女雙

(7局制) 取前 6 名

A 循環取前二名(A2 抽 2.3.4.5 號籤)，其餘取第一名進入單敗決賽，分組循環名次一經確認，立即由大會現場抽籤。

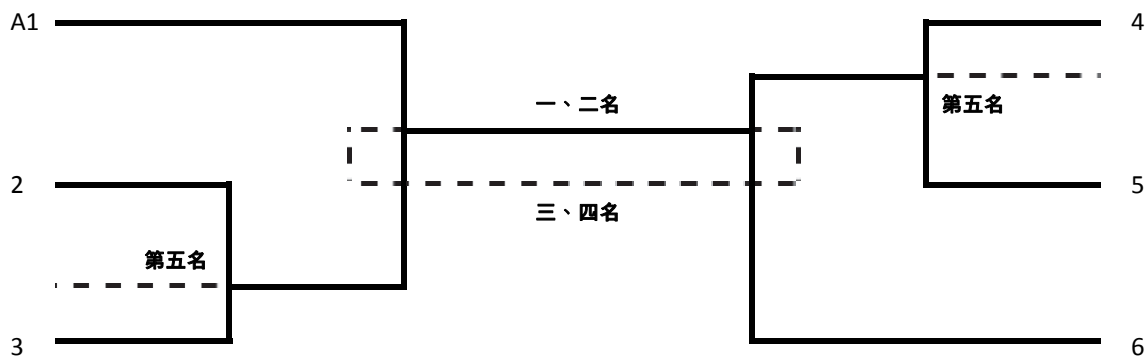
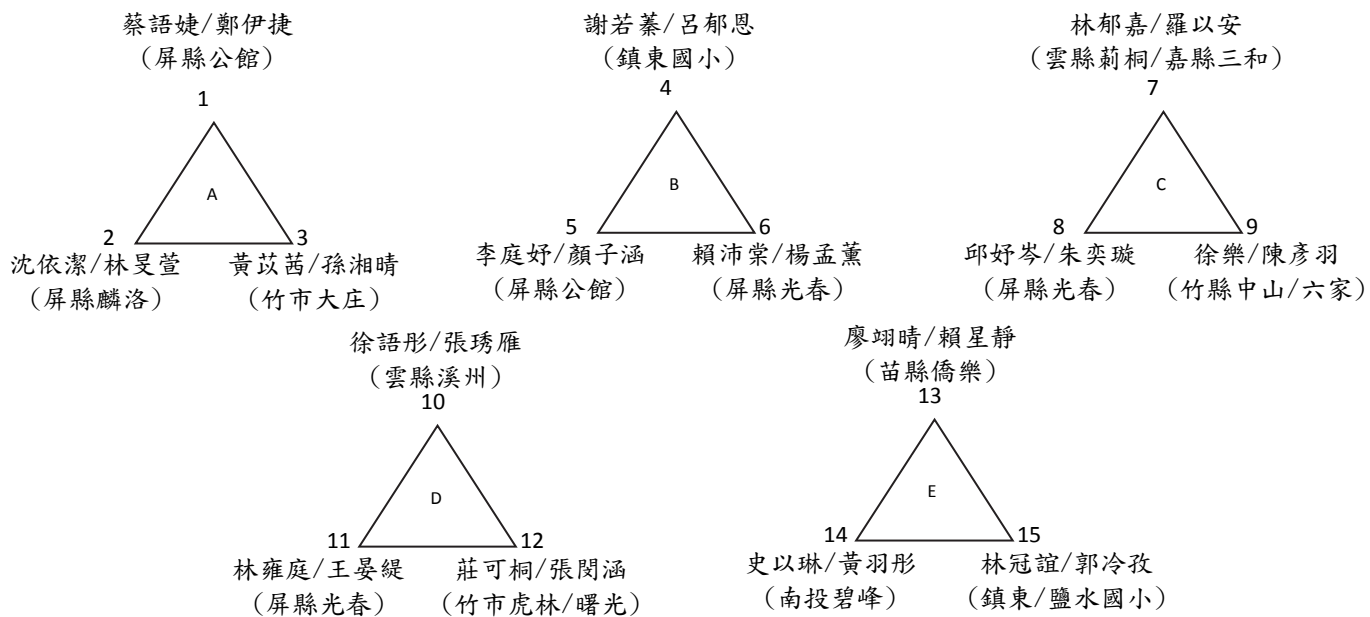

U11 男雙

(7局制) 取前 8 名

A 循環取前二名(A2 抽 2. 3. 4. 5. 8. 9. 10. 11 號籤)，其餘取第一名進入單敗決賽，分組循環名次一經確認，立即由大會現場抽籤。

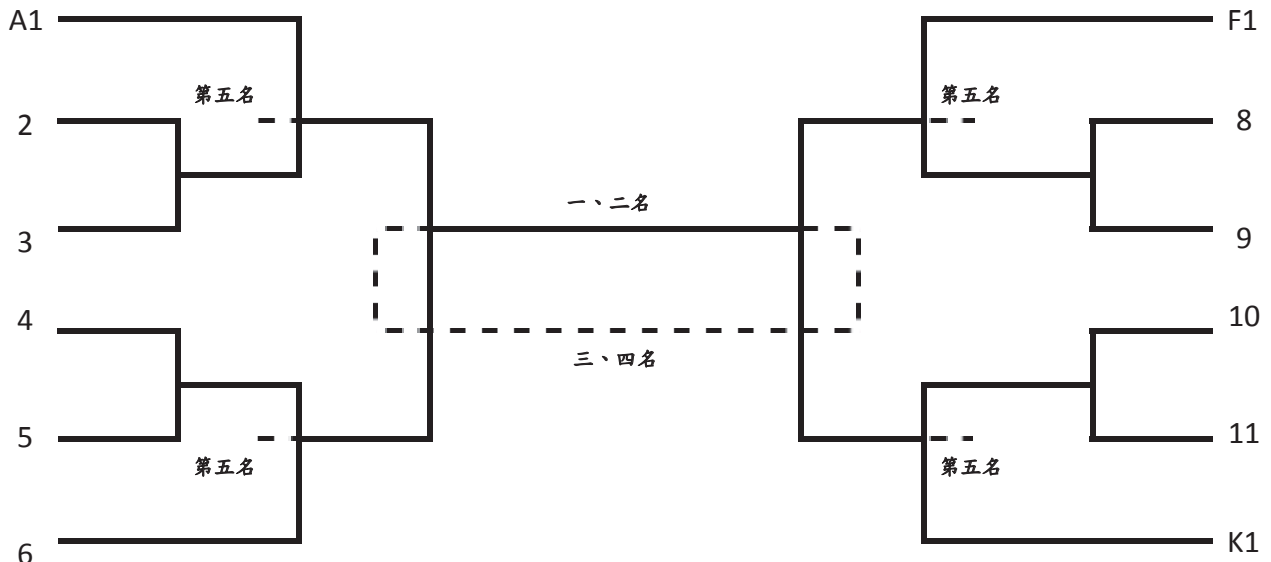
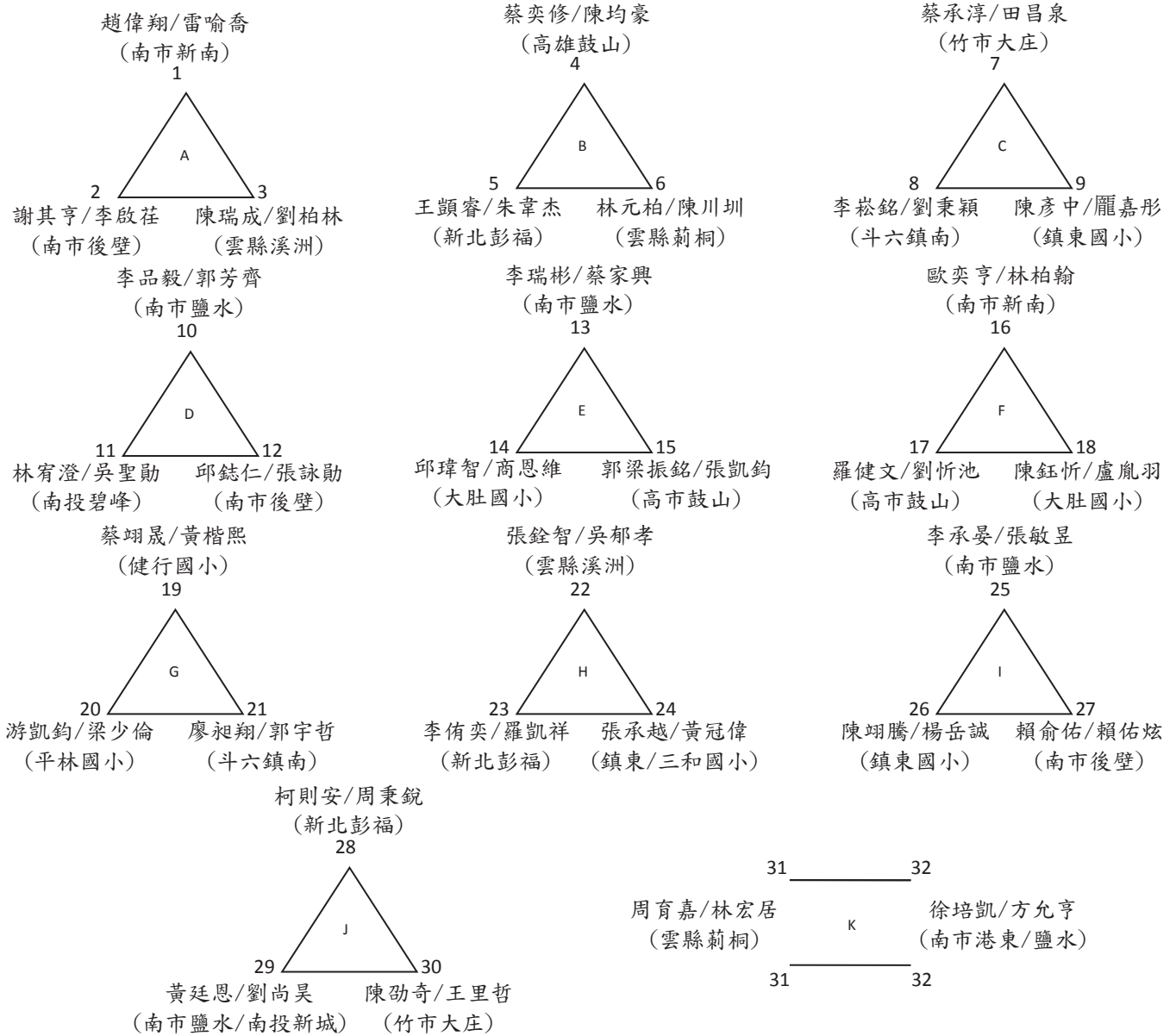

U11 女雙

(7局制) 取前 6 名

取分組循環第一名進入單敗決賽，分組循環名次一經確認，立即由大會現場抽籤。

劉妍伶/林恩如
(三和國小)

1

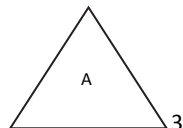

張靜慧/李芯 (屏縣公館) 林禾倩/唐子喬 (南市新南)

張玲慄/謝宛紘
(高市鼓山)

4

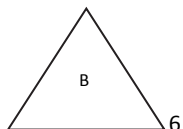

徐簡愷彤/辛婕妤 (屏縣公館) 譚茹芸/孫苡捷 (苗縣僑樂)

廖紫妤/烏念妤
(新北彭福)

7

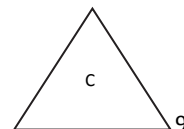

周乃文/吳聖筑 (南縣碧峰) 黃馨霏/余舒帆 (鎮東國小)

劉馥瑜/張慧婕
(新北彭福)

10

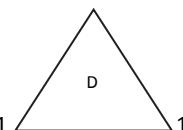

林家瑄/鐘玥淇 (鎮東/大肚國小) 巫采霓/黃子瑄 (高市鼓山)

董于潔/卓彥蓁
(南市後壁/)

13

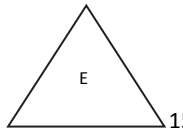

張凱甯/陳靖惟 (高市鼓山) 陳念慈/鍾語純 (苗縣僑樂)

吳宇秧/林純真
(南市港東)

16

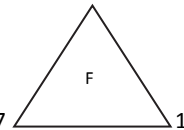

簡慎萱/林彥辰 (東榮國小) 吳怡霏/張閔璇 (竹市西門/曙光)

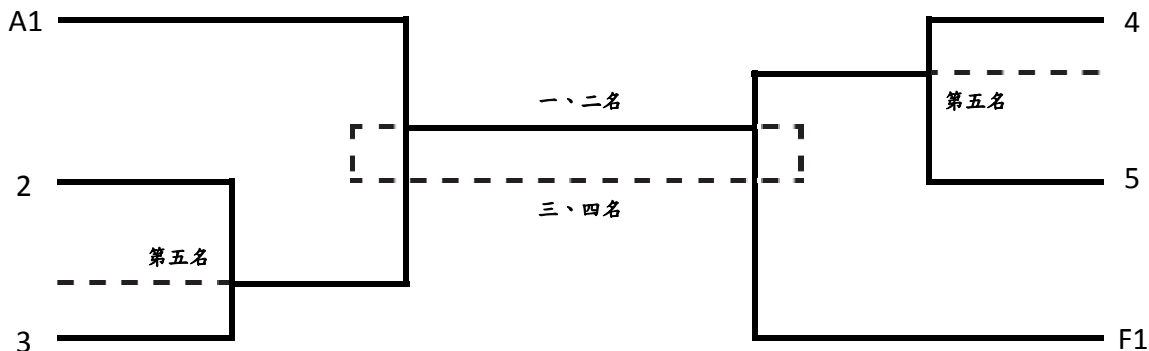

U12 男雙

(7局制) 取前 8 名

取分組循環第一名進入單敗決賽，分組循環名次一經確認，立即由大會現場抽籤。

鄭松騏/林尚偉
(南市港東)

1

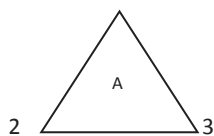

林泰丞/李昱磊 王冠智/周柏瑞
(雲縣荊桐) (三和國小)

陳信豪/林承毅
(雲縣荊桐)

10

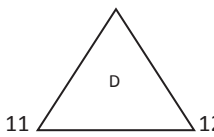

林政巖/吳其澤 鄭博鴻/鍾子勛
(竹縣竹仁) (雲縣溪洲)

趙偉志/雷喻翔
(南市新南)

19

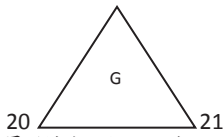

郭冠昇/林振竹 黃蕭欣倫/陳廷豐
(斗六鎮南) (花縣鳳林)

林宥橙/孫岳宏
(竹市大庄)

28

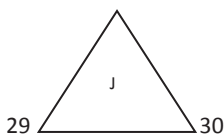

王昱杰/張菘晏 張台宇/張台澈
(竹市朝山/西門) (中市忠明)

張佑全/高玄祐
(鎮東國小)

4

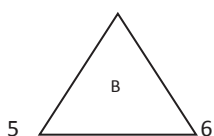

林建維/鄭釗聰 黃岑育/黃彥甫
(三和國小) (屏縣麟洛)

林家榮/林芯卉
(雲縣溪洲)

13

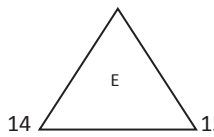

吳柏賢/陳祉齊 葉宜嘉/王瀚澤
(南市/省躬鹽水) (新北彭福/大同)

吳祐任/王鉞凱
(新北彭福)

22

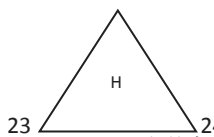

陳冠均/陳冠捷 許鈞凱/江旻軒
(平林國小) (健行國小)

陳睿邦/黃泊霖
(花縣鳳林)

31

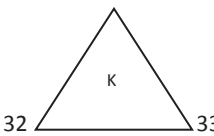

趙玟淞/洪元豐 吳承峻/陳星允
(南市鹽水/新南) (鎮東國小)

范振宏/莊廷宇
(竹縣竹仁/苗縣新南)

7

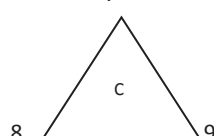

陳敬詣/湯頤 李承恩/朱瑞慈
(竹市大庄) (花縣鳳林)

陳宥均/黃祐晟
(中市忠明)

16

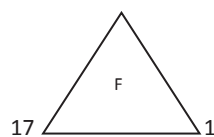

楊博鈞/李晟睿 林澤杰/李宥醇
(竹縣竹仁/苗縣新南) (雲縣荊桐)

陳廖上軒/姚宥銘
(竹市東門/苗縣新南)

25

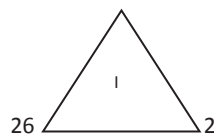

王宥謹/黃智緯 楊博勛/廖寬錠
(竹市新竹/民富) (北市彭福)

林荃楷/林信安
(雲縣荊桐)

34

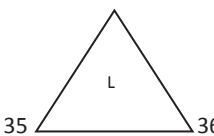

張喬博/巫嘉恩 林翊弘/陳柏翰
(高市鼓山) (三和國小)

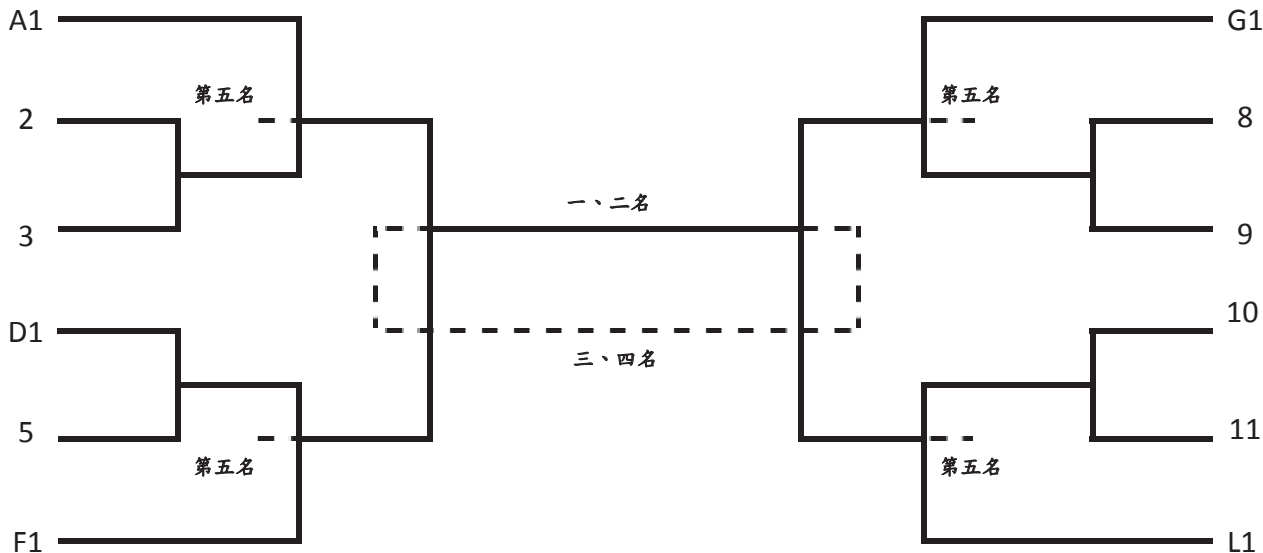

U12 女雙

(7局制) 取前 4 名

A 循環取前二名(A2 抽 2.3.4 號籤)，其餘取第一名進入單敗決賽，分組循環名次一經確認，立即由大會現場抽籤。

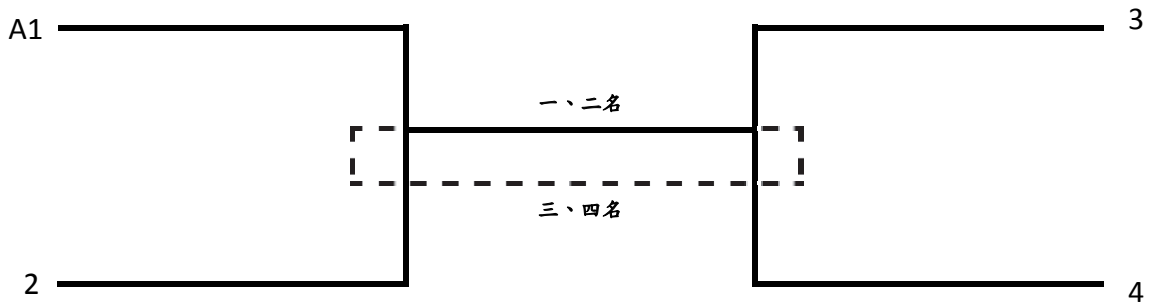
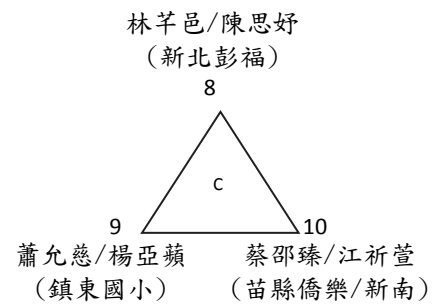
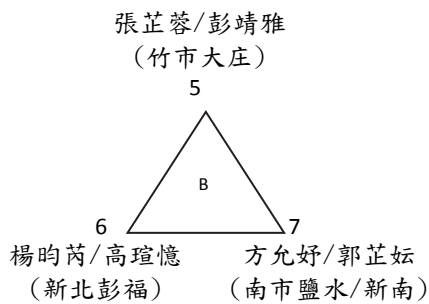
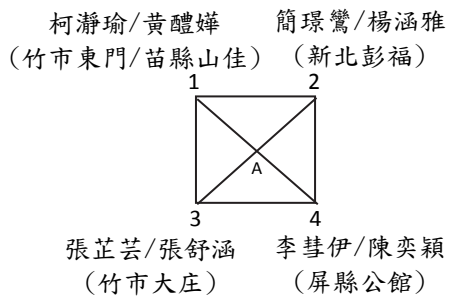

U12 男單

(八強前5局制) 取前8名

取分組循環第一名進入單敗決賽，分組循環名次一經確認，立即由大會現場抽籤。

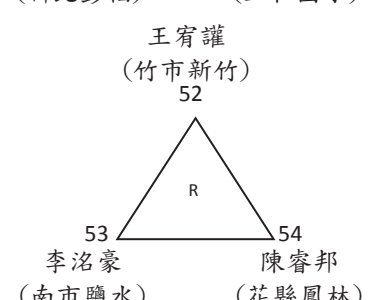
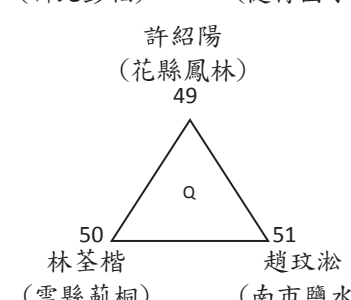
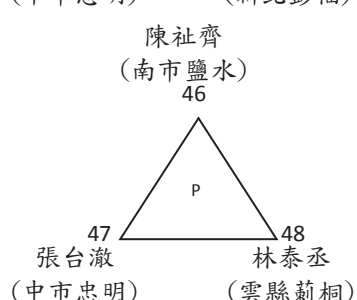
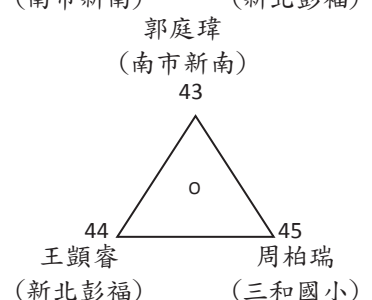
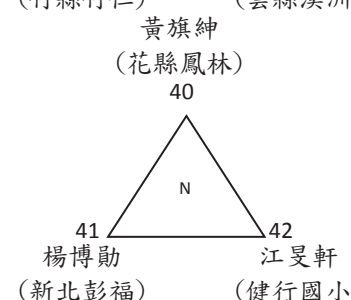
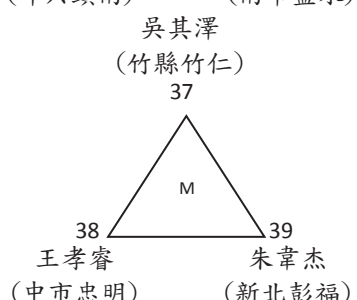
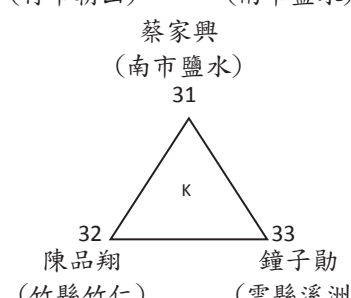
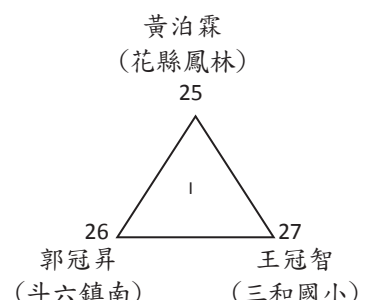
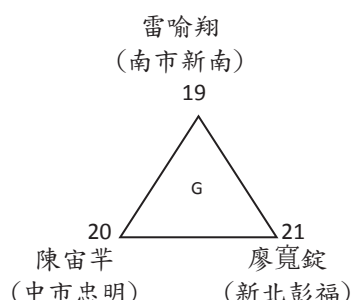
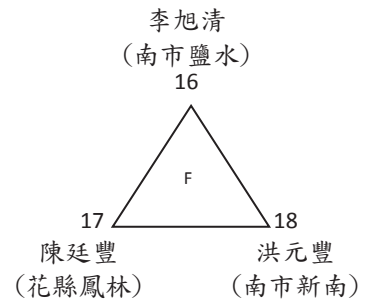
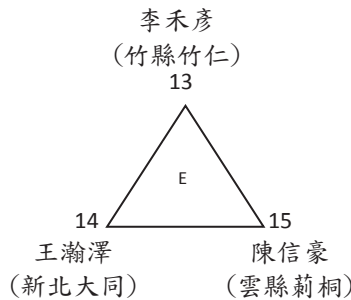
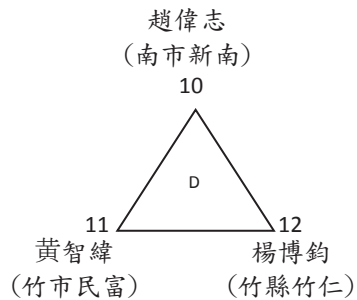
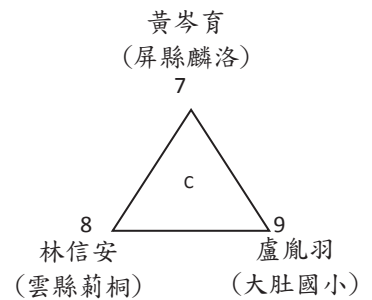
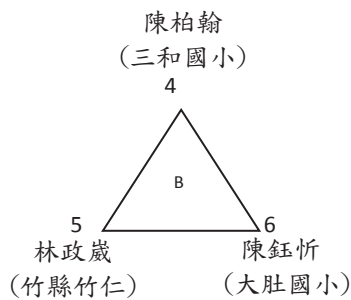
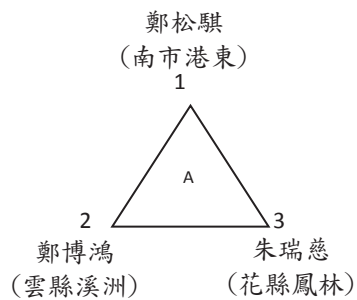

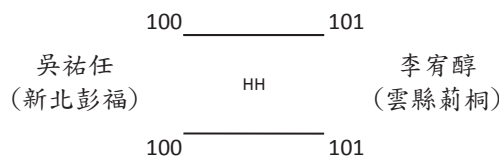
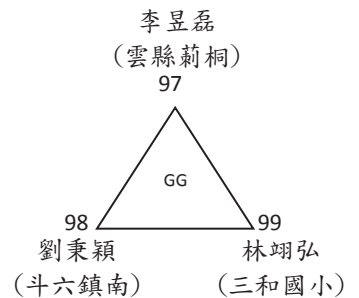
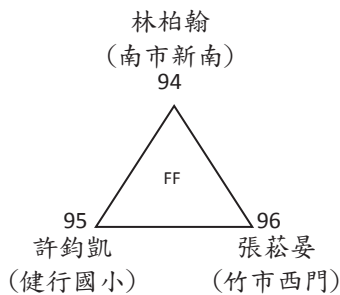
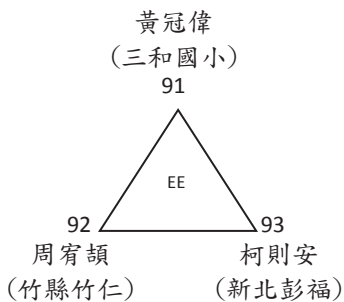
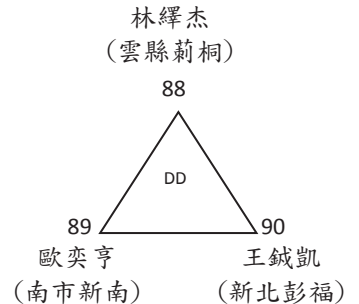
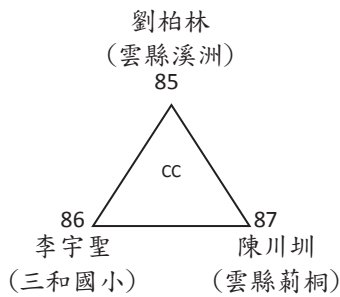
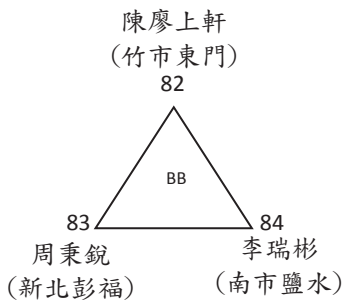
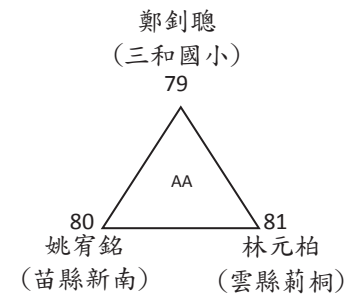
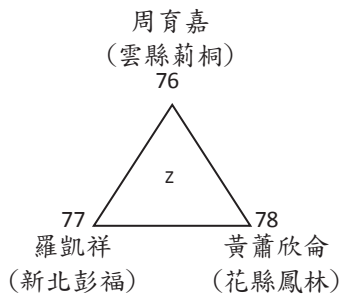
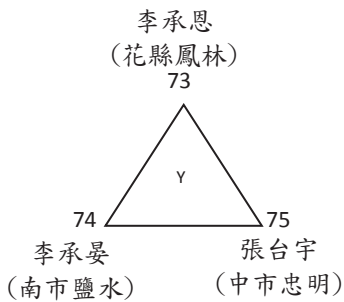
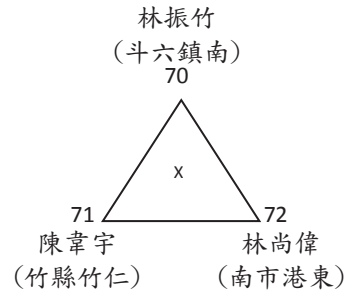
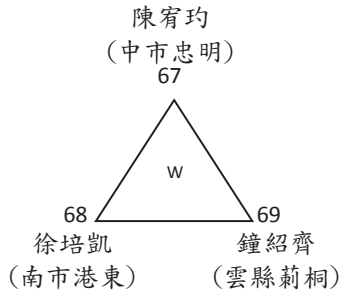
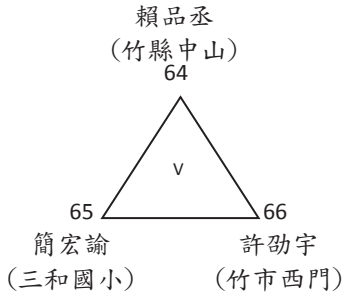
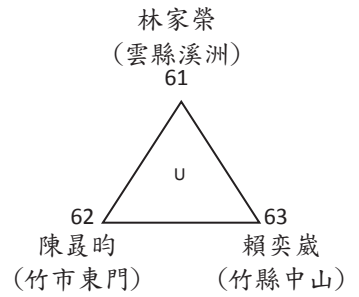
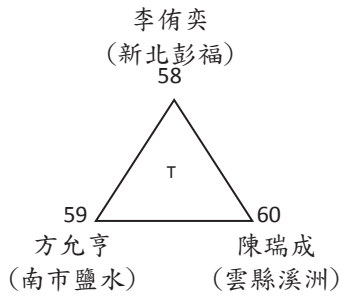
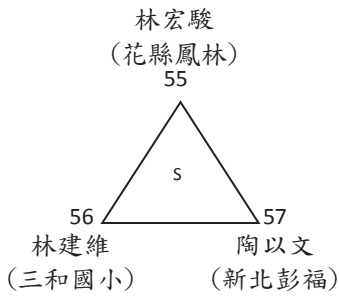

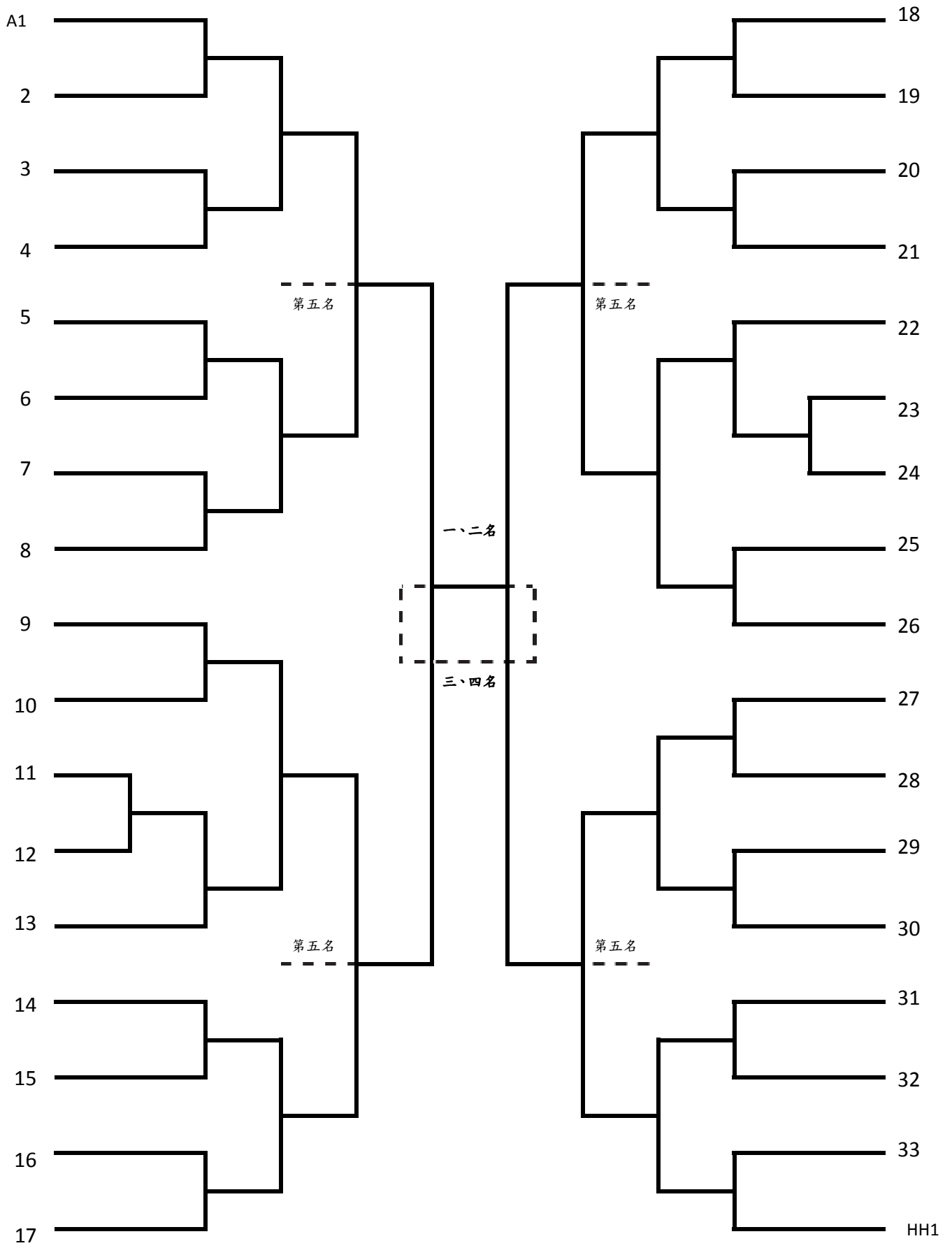

U12 女單

(八強前5局制)取前8名

取分組循環第一名進入單敗決賽，分組循環名次一經確認，立即由大會現場抽籤。

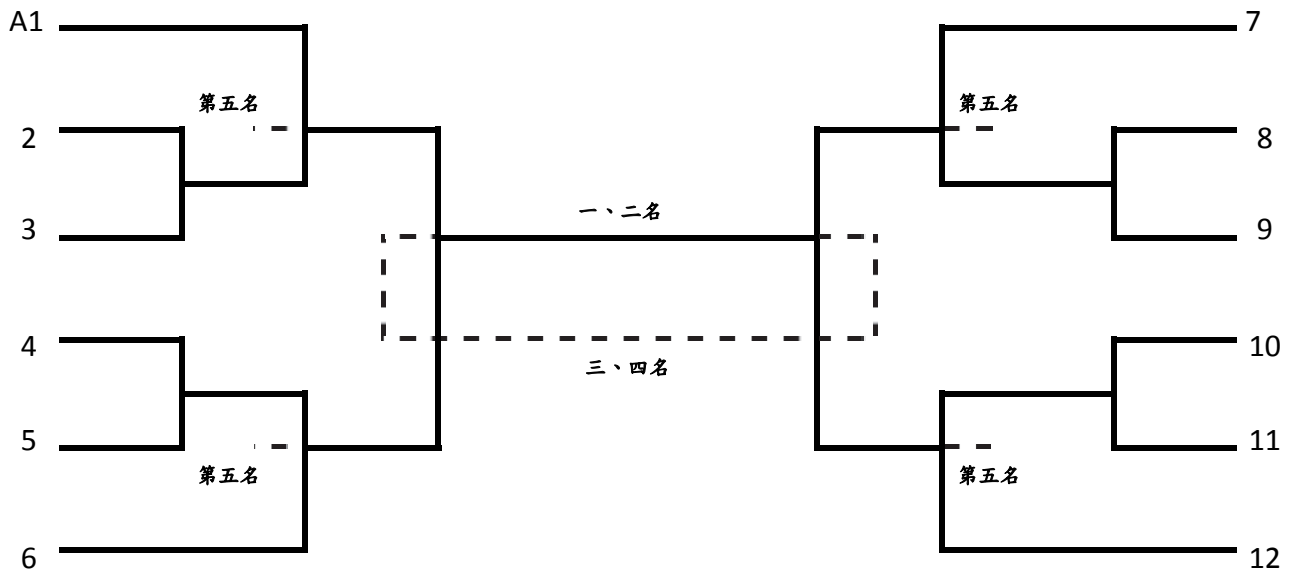
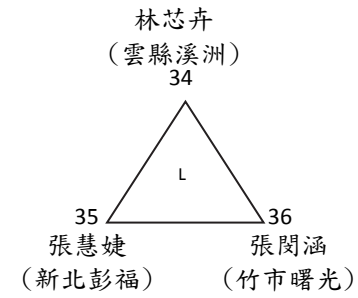
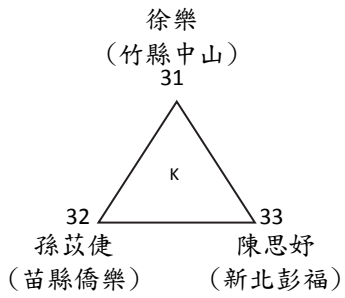
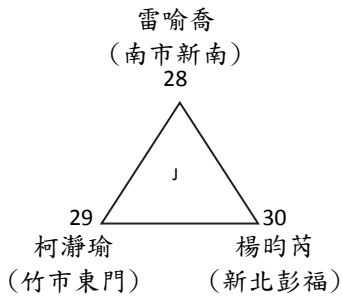
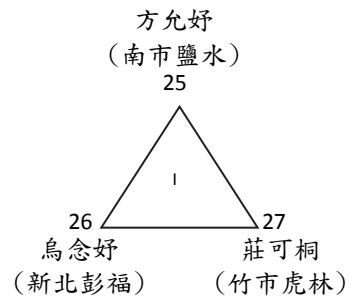
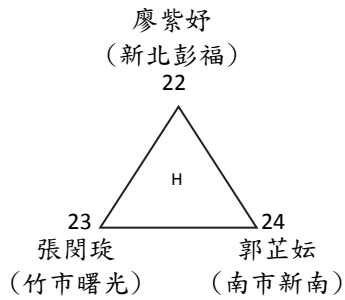
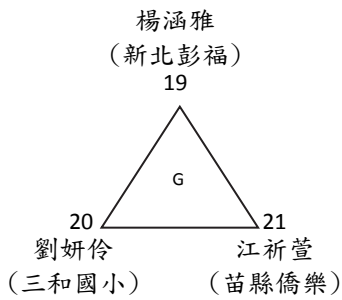
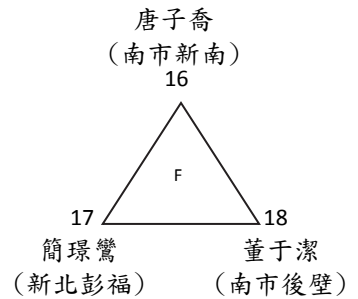
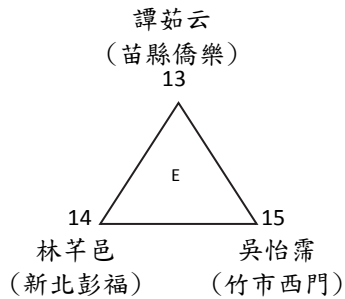
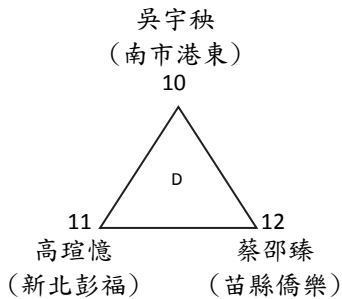
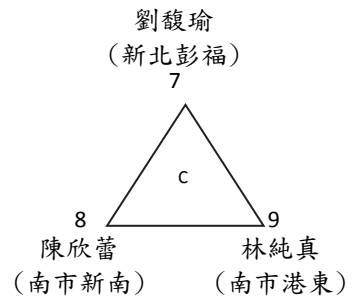
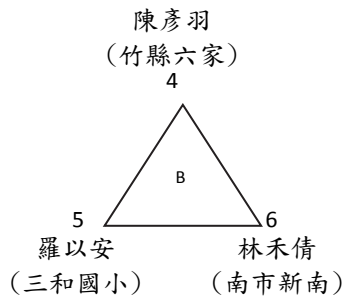
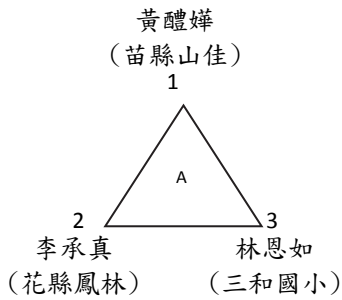

U15 男雙

(7局制)取前8名

落入敗部後，隨即由大會公開抽籤決定號位

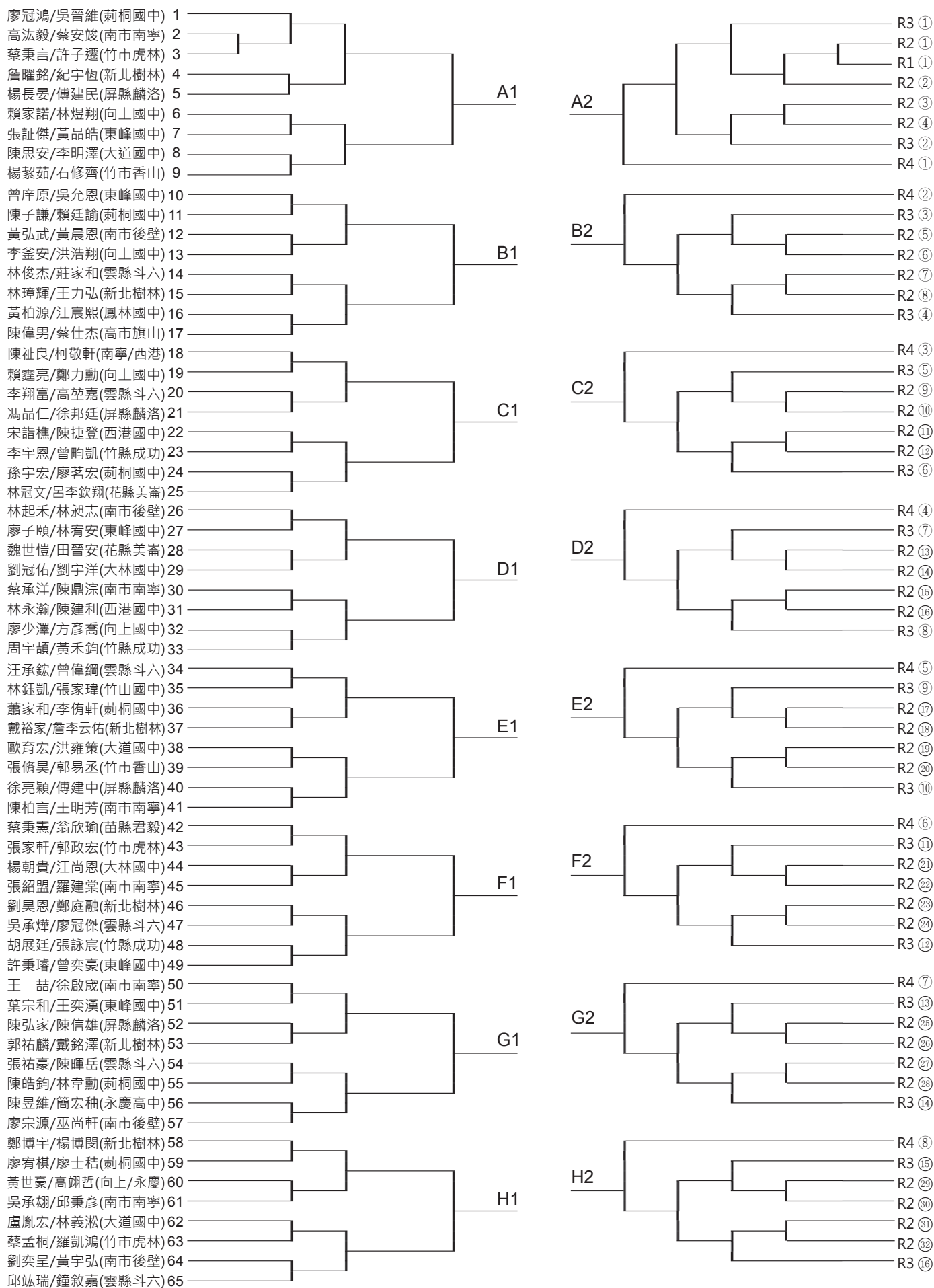

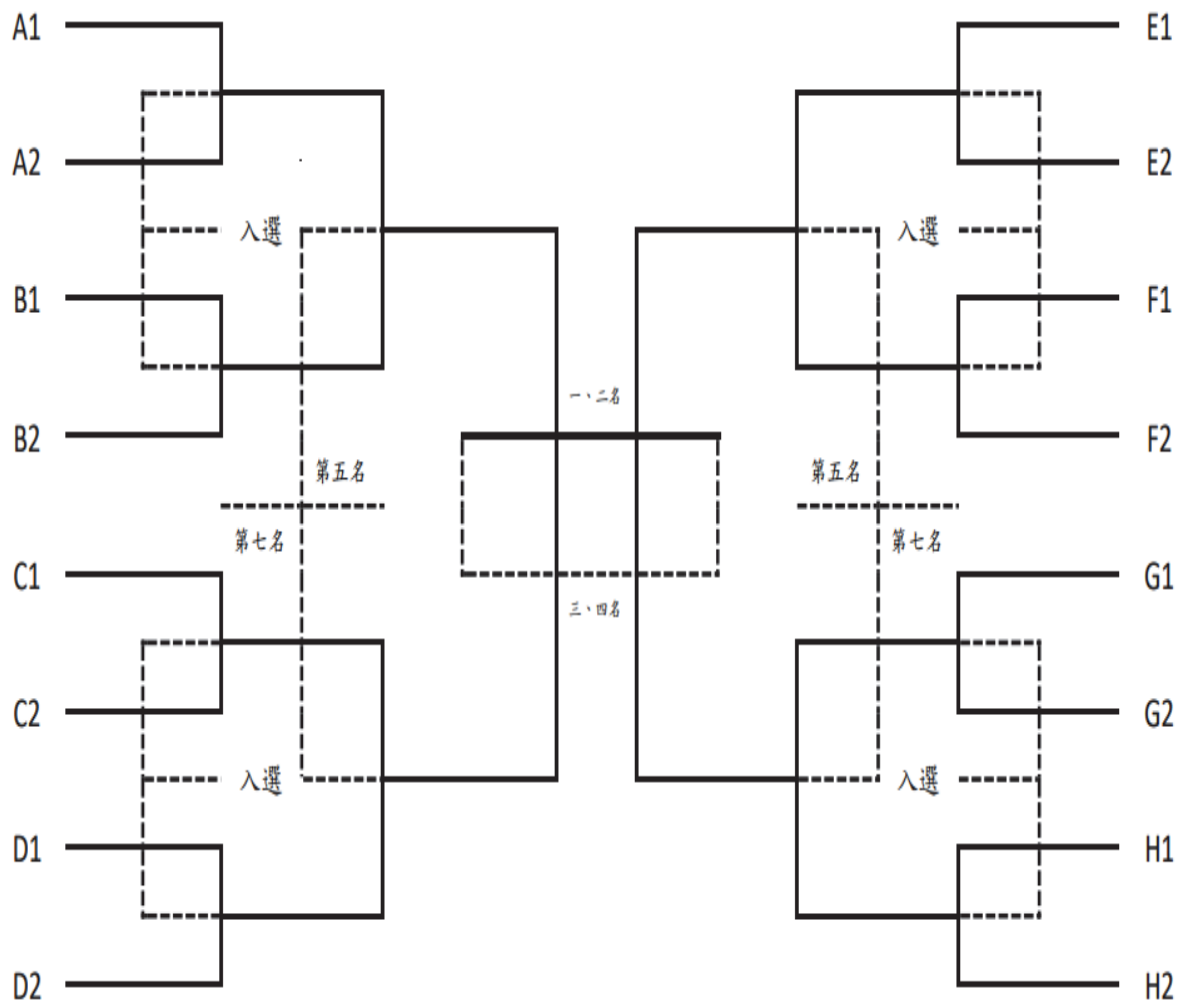

U15 女雙

(7局制)取前8名

落入敗部後，隨即由大會公開抽籤決定號位

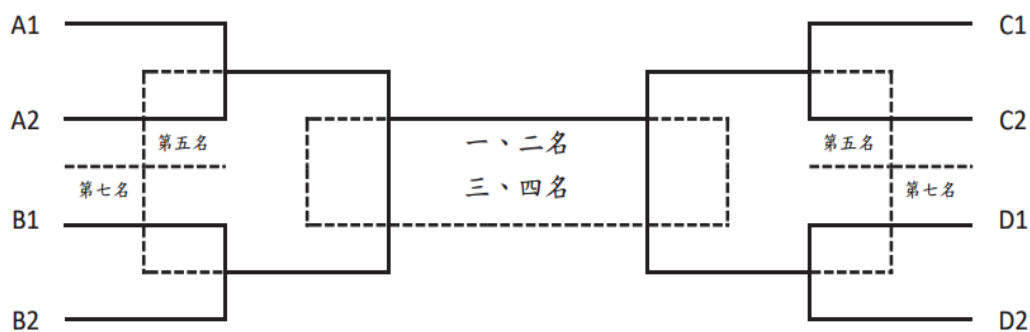
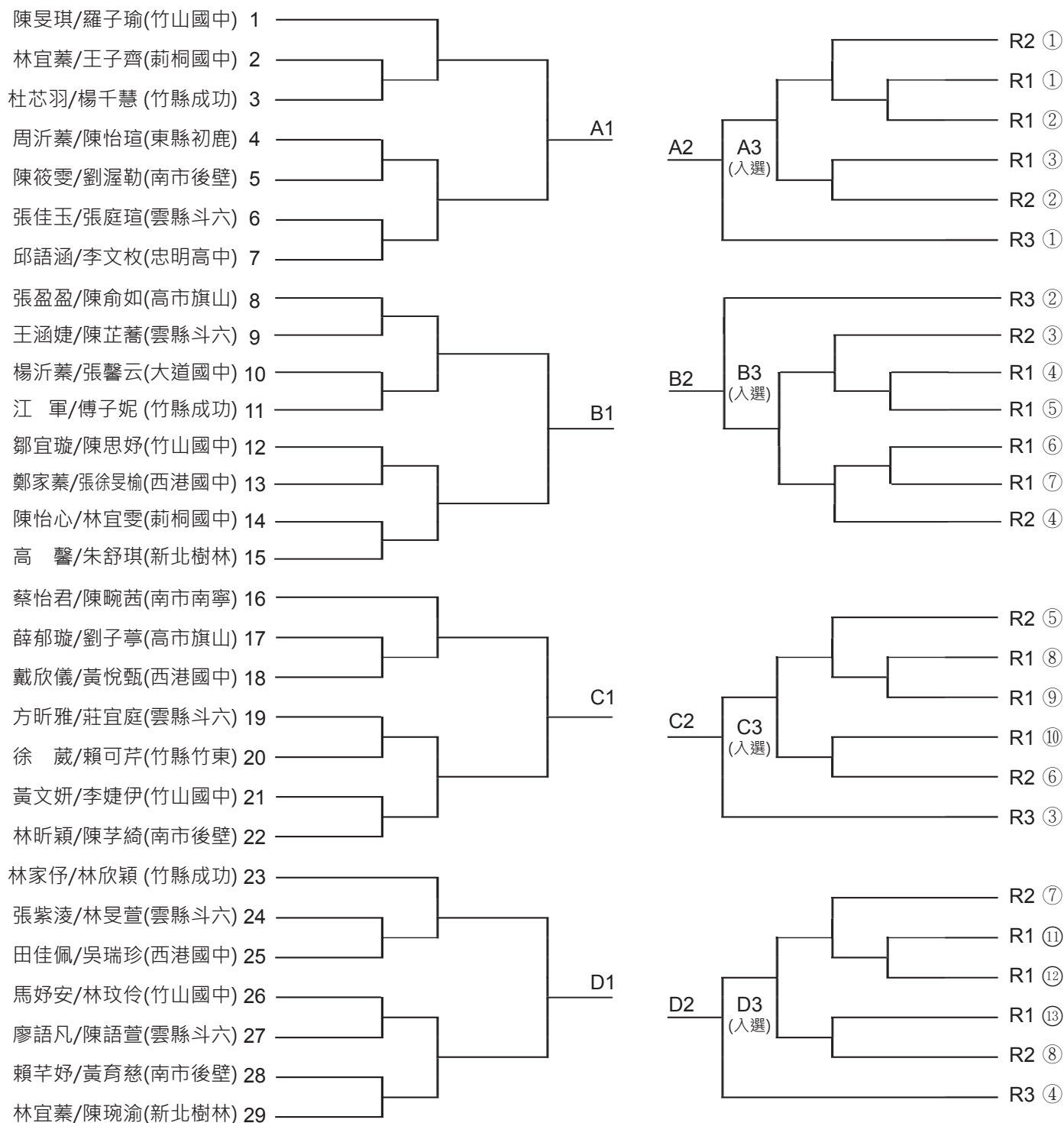

U18 男雙

(7局制)取前8名

落入敗部後，隨即由大會公開抽籤決定號位

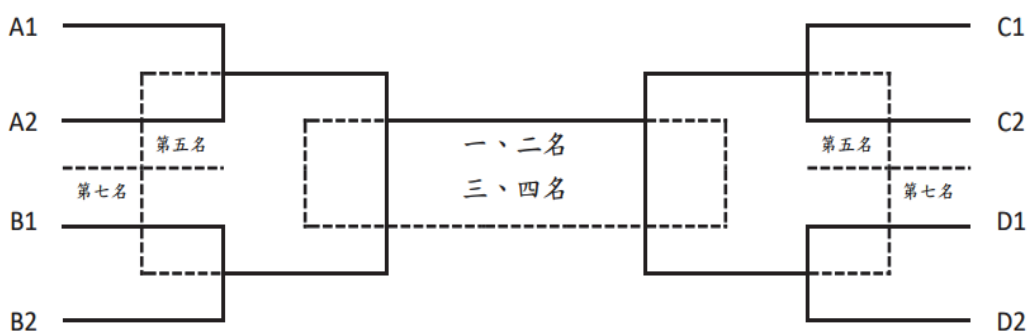
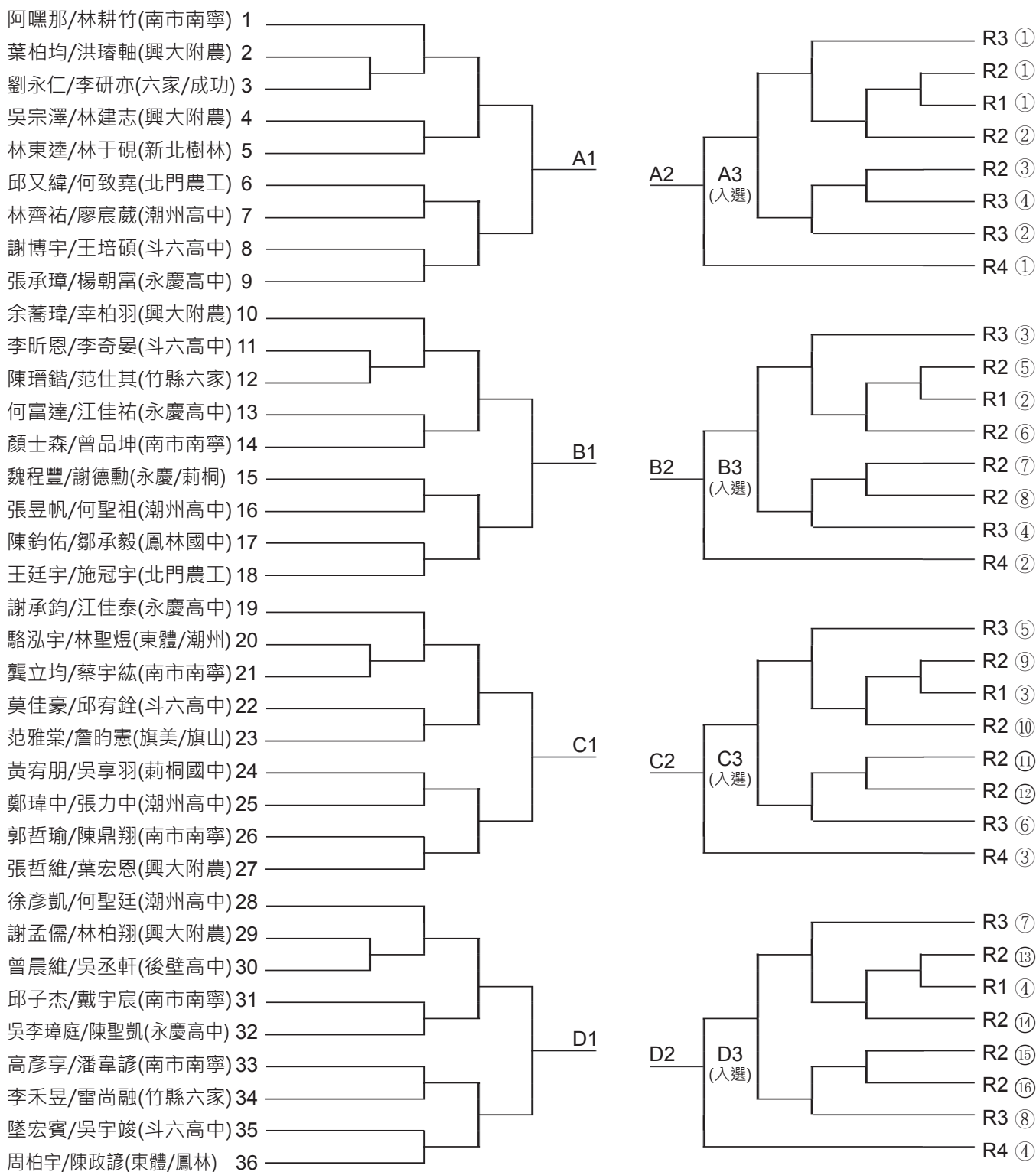

U18 女雙

(7局制)取前6名

落入敗部後，隨即由大會公開抽籤決定號位

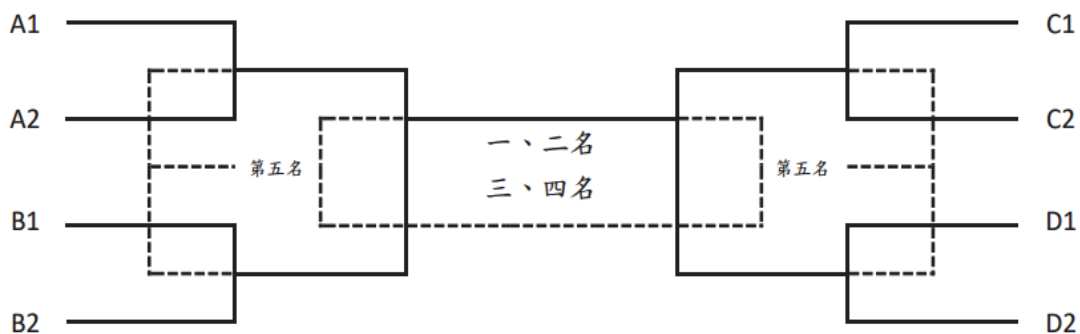
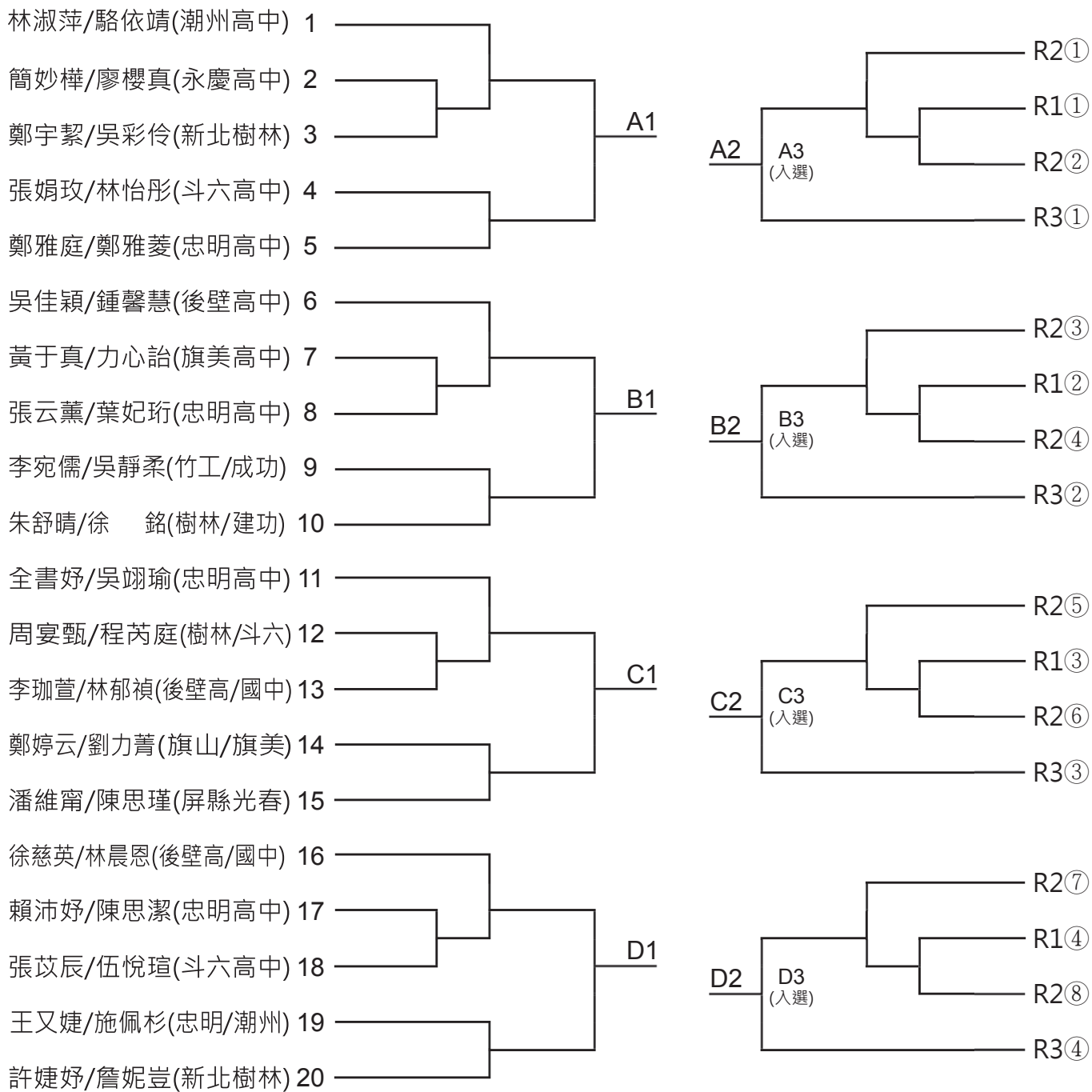

U21 男雙

(7局制)取前6名

落入敗部後，隨即由大會公開抽籤決定號位

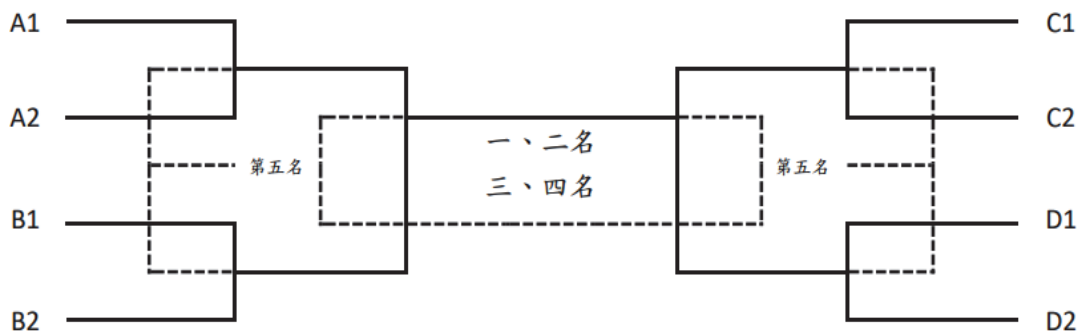
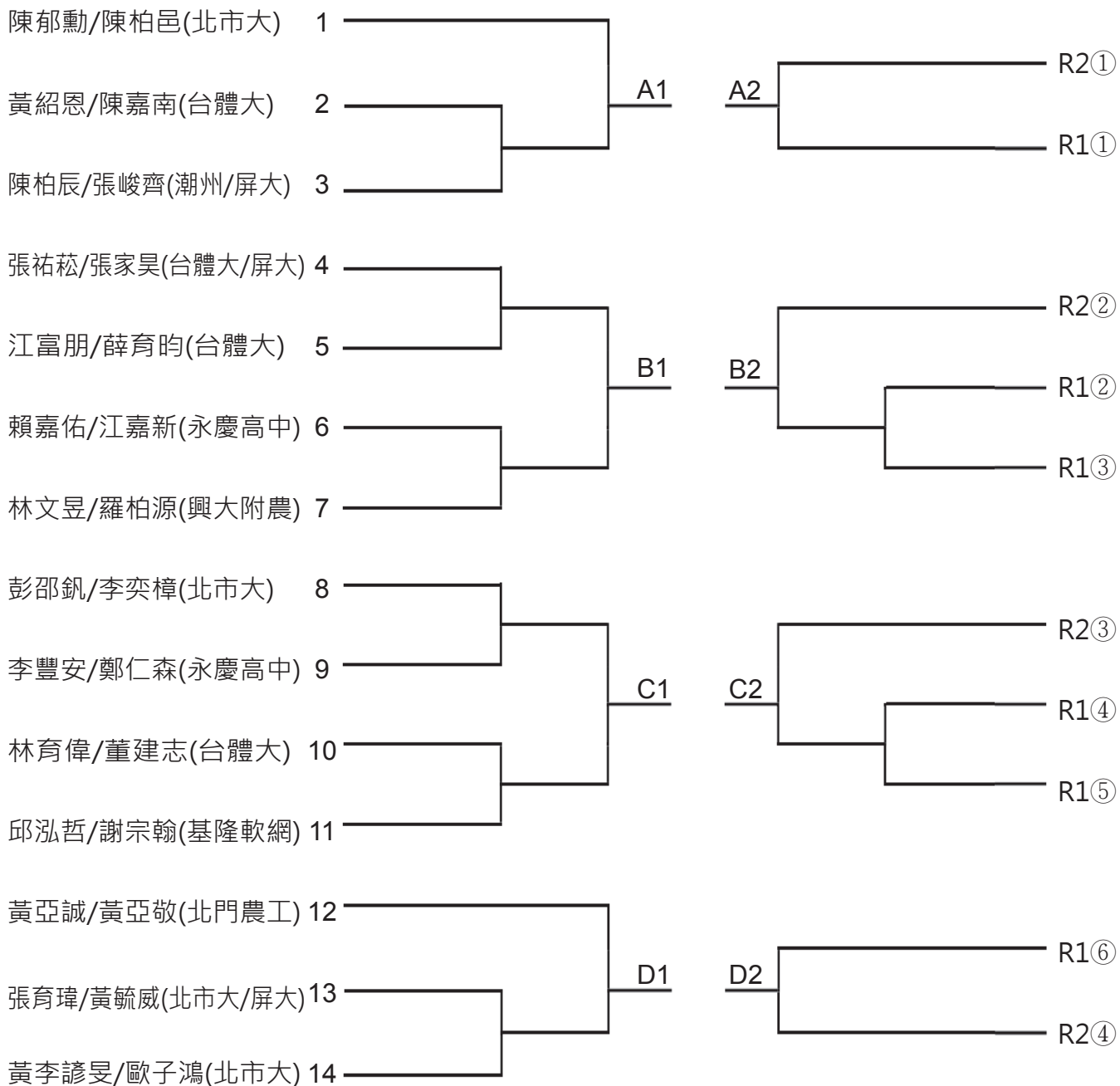

U21 女雙

(7局制)取前3名

落入敗部後，隨即由大會公開抽籤決定號位

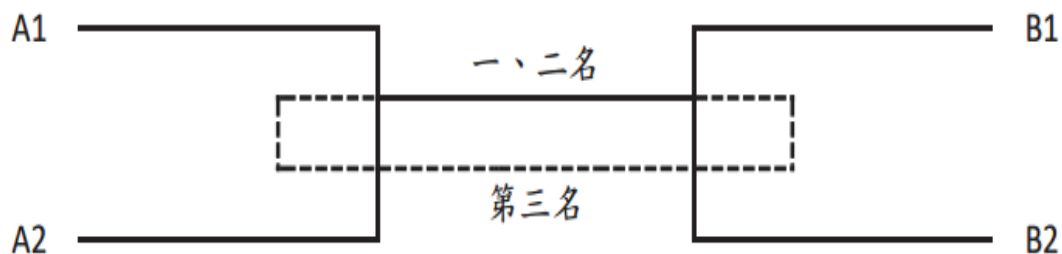
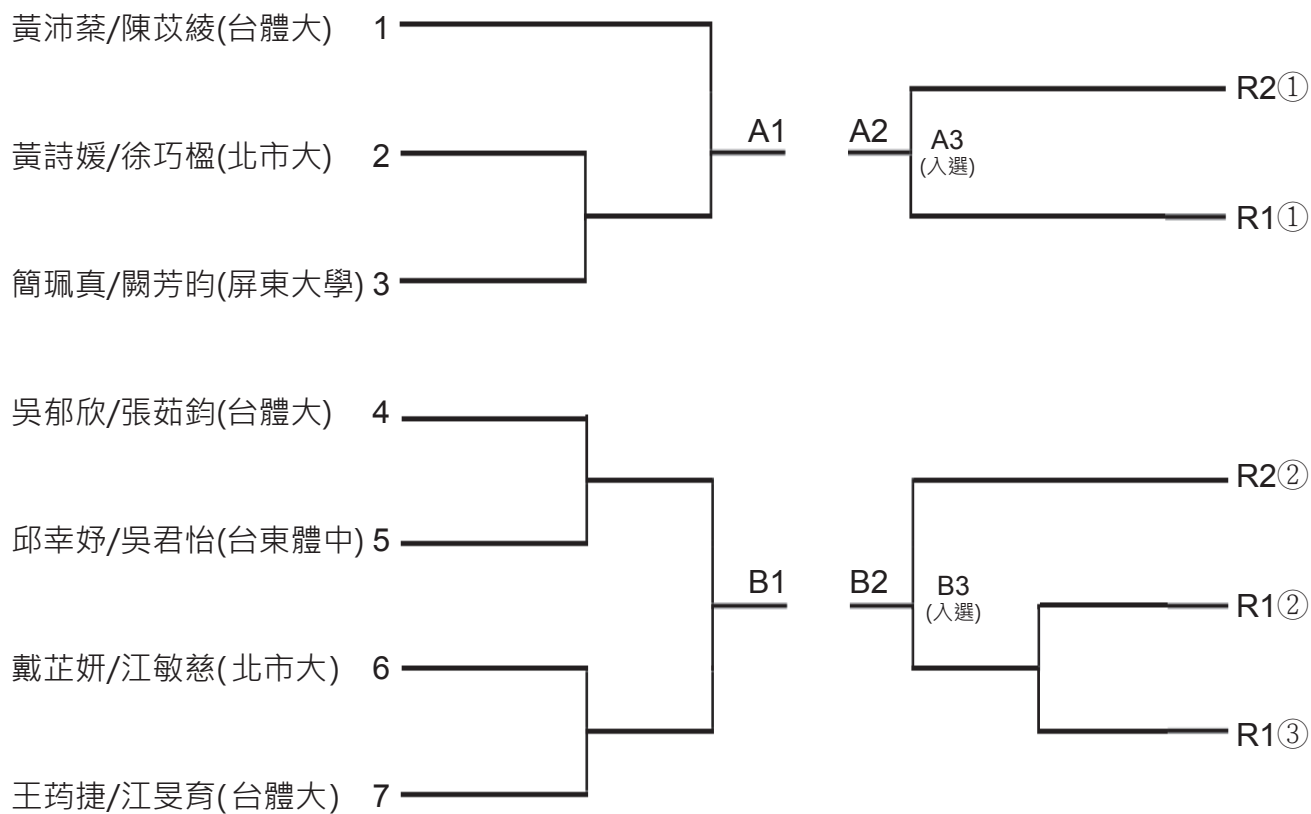

U15 男單

(八強前5局制) 取前8名

落入敗部後，隨即由大會公開抽籤決定號位

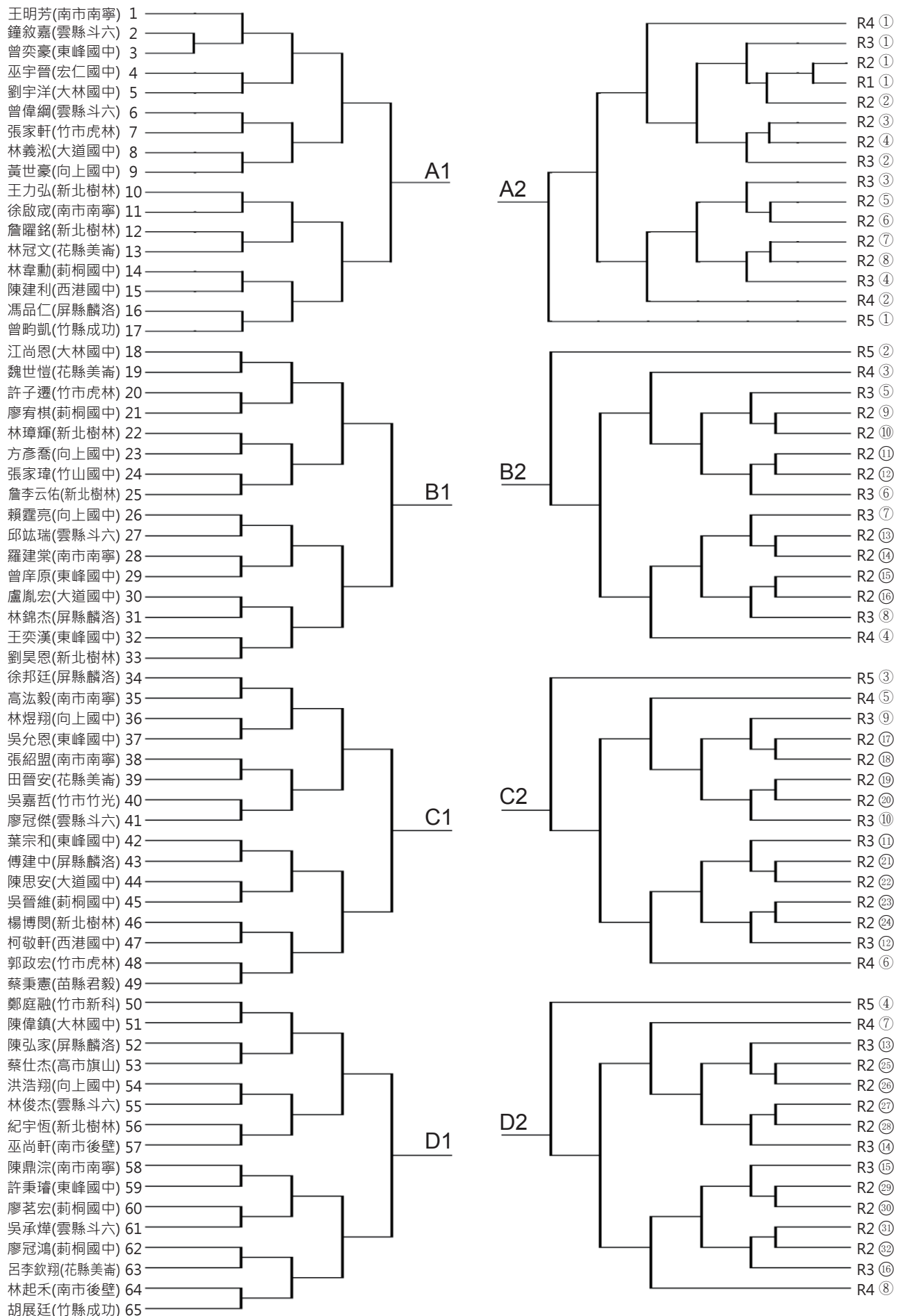

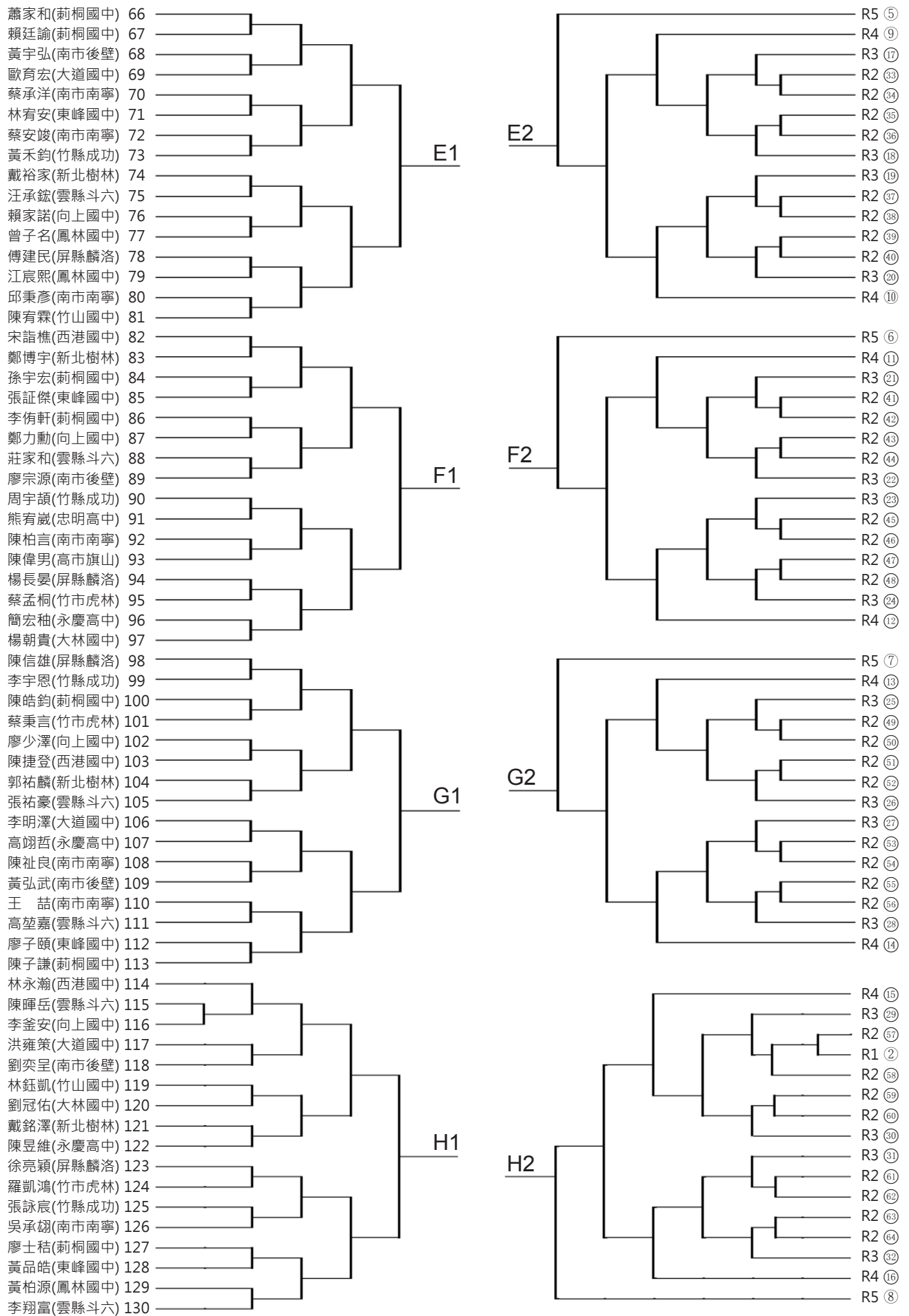

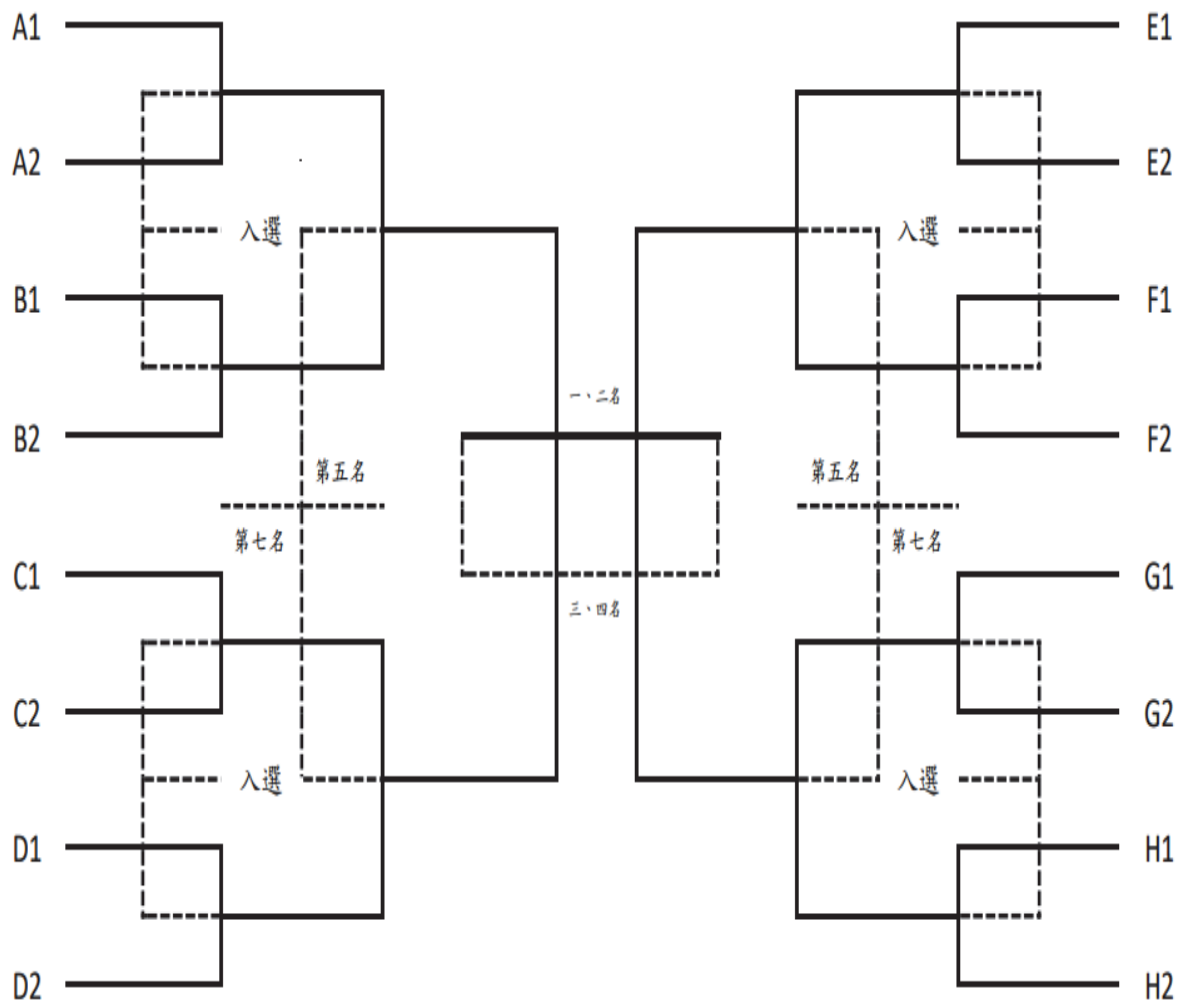

U15 女單

(八強前 5 局制) 取前 8 名

落入敗部後，隨即由大會公開抽籤決定號位

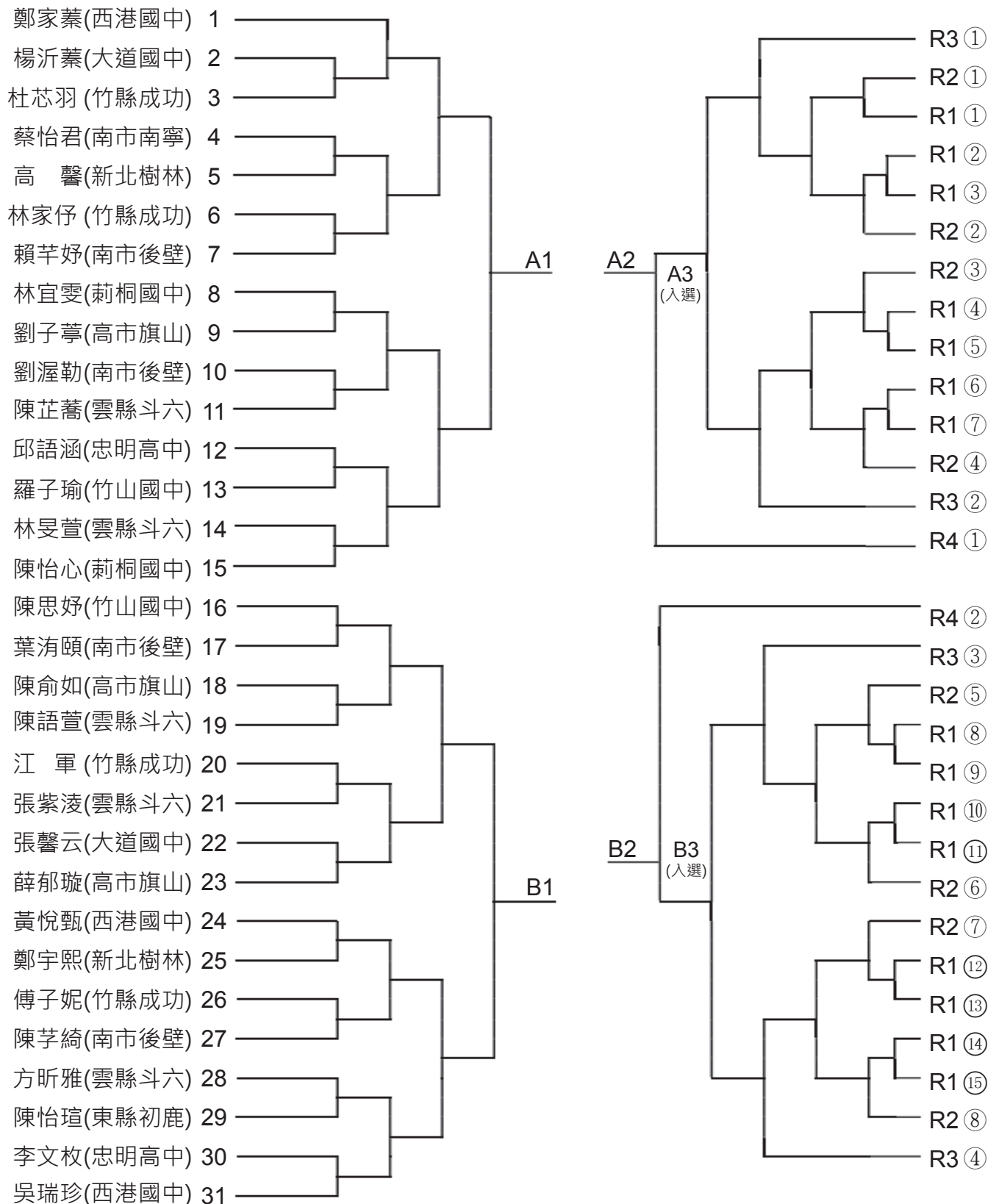

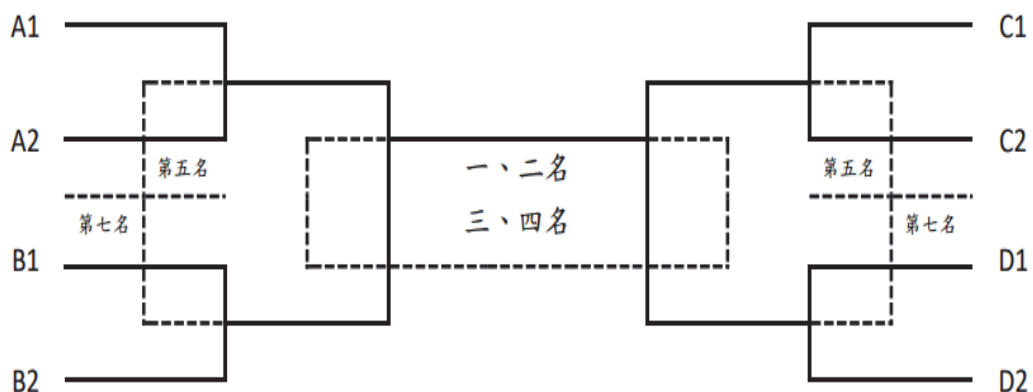
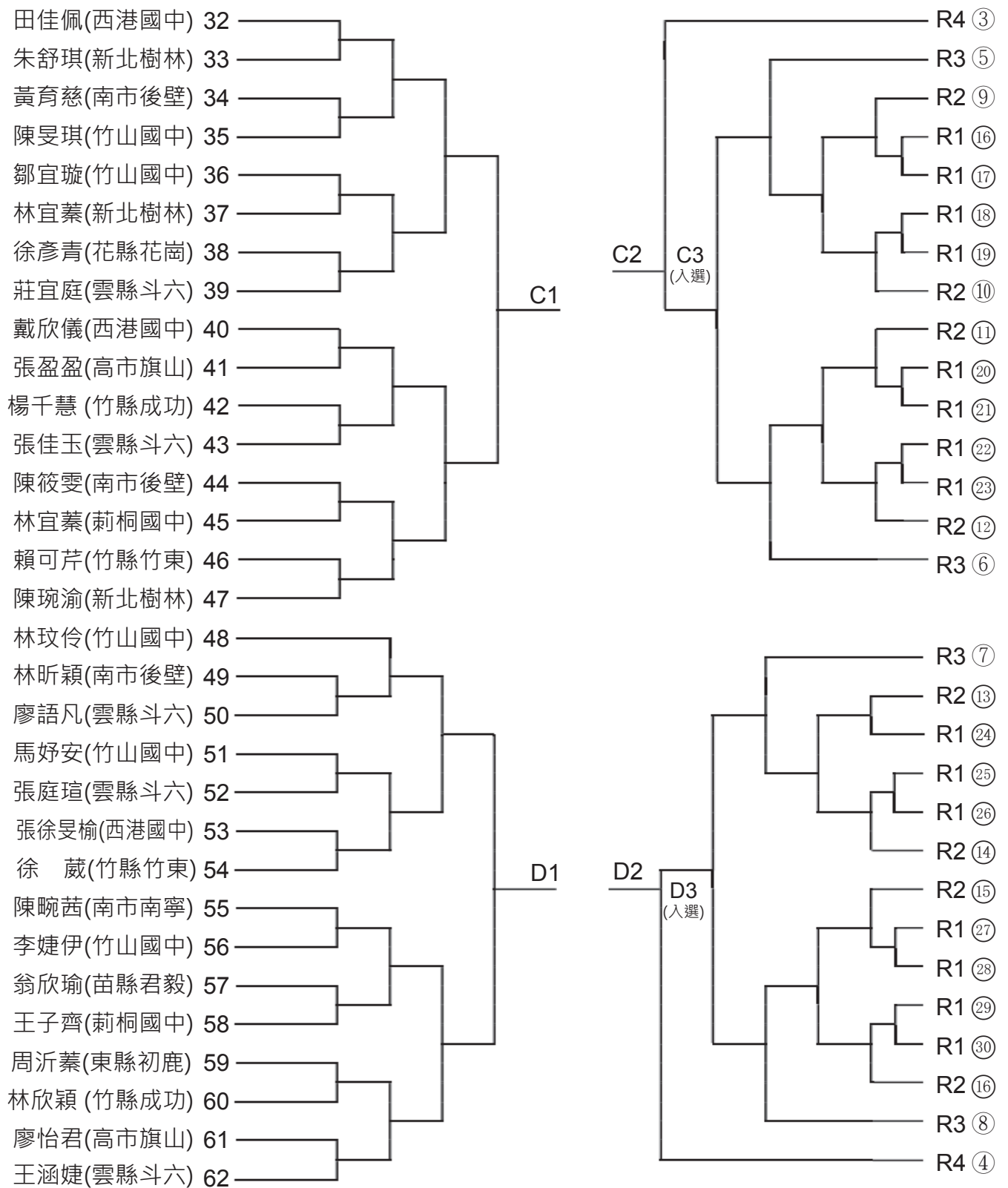

U18 男單

(八強前 5 局制) 取前 8 名

落入敗部後，隨即由大會公開抽籤決定號位

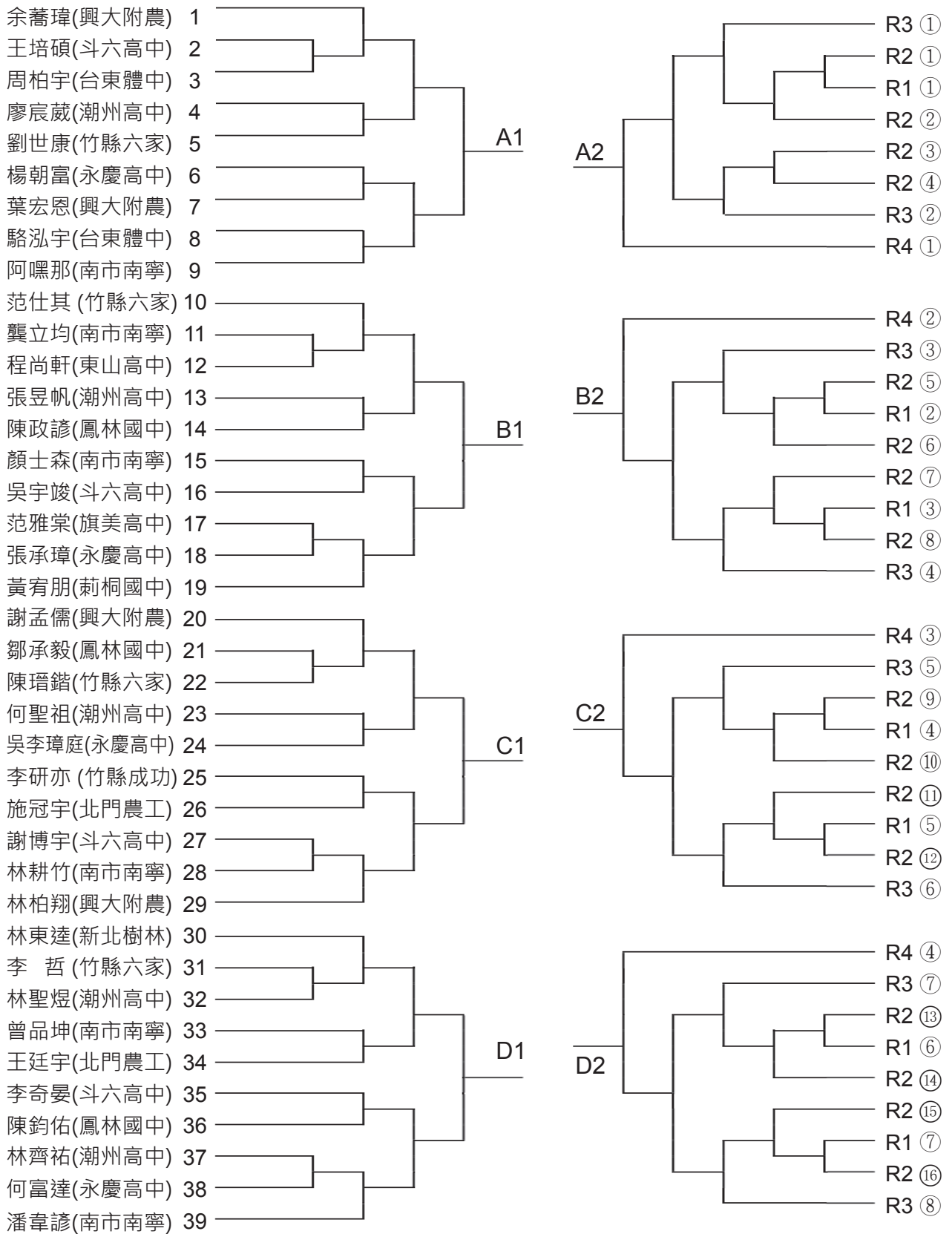

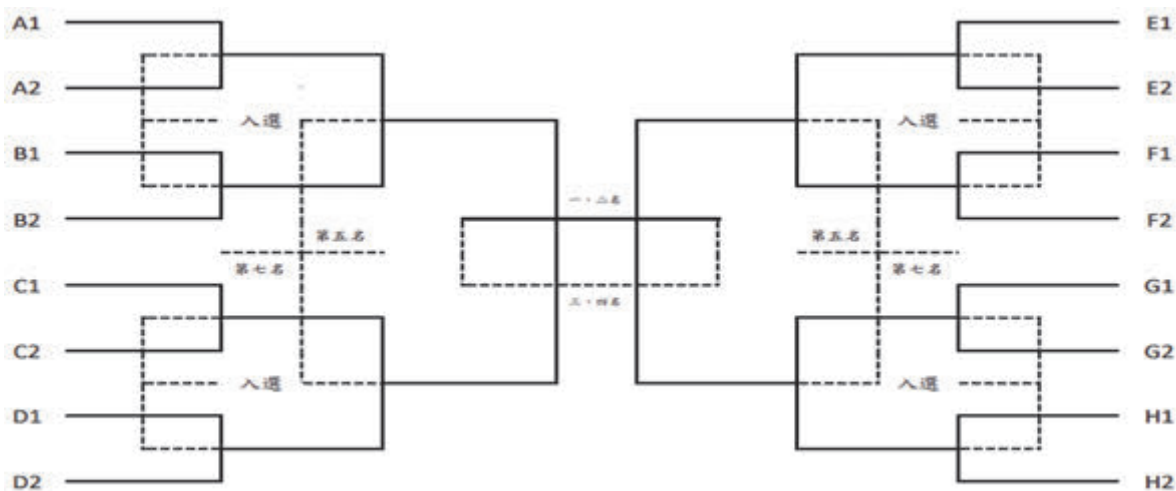
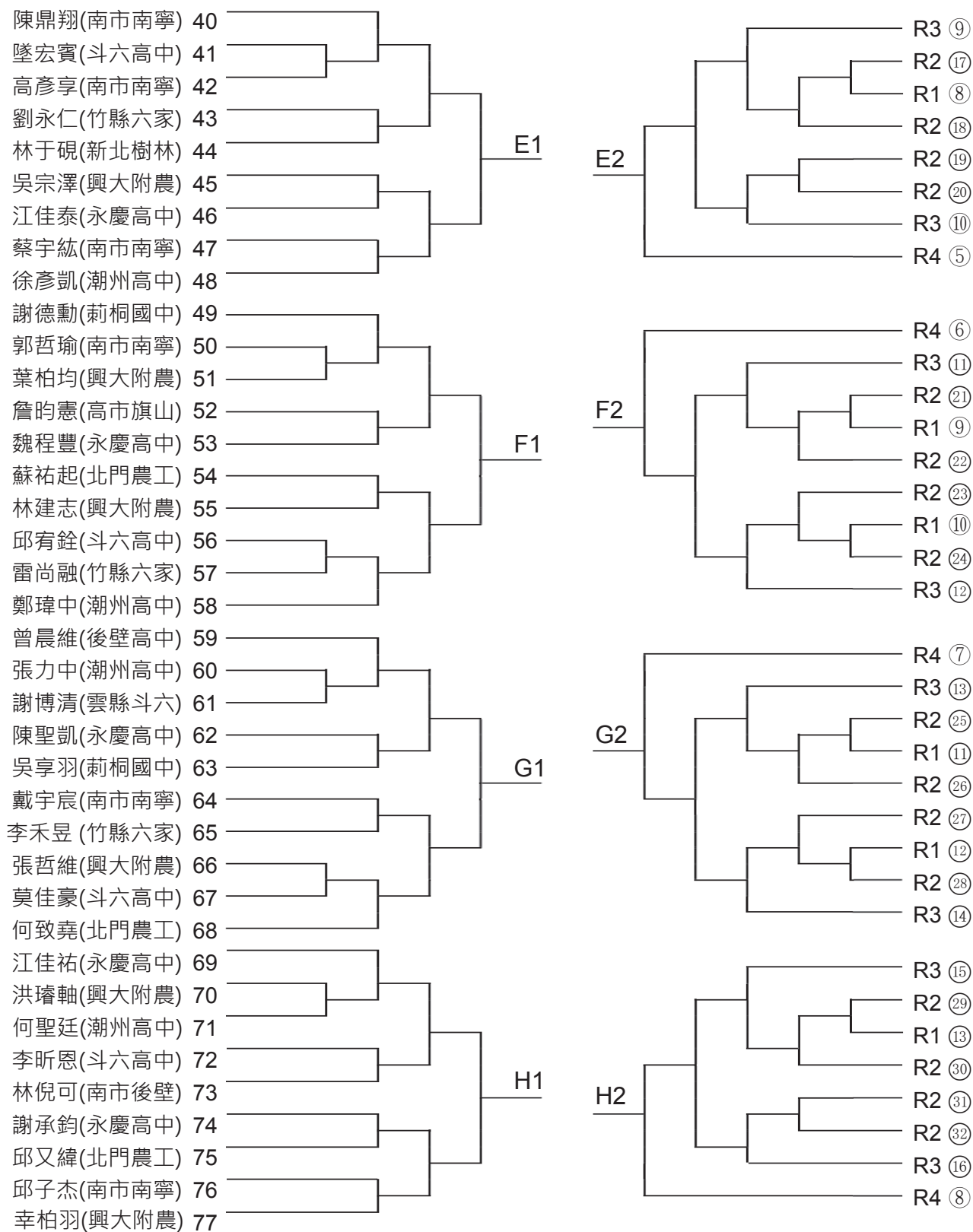

U18 女單

(八強前 5 局制) 取前 8 名

落入敗部後，隨即由大會公開抽籤決定號位

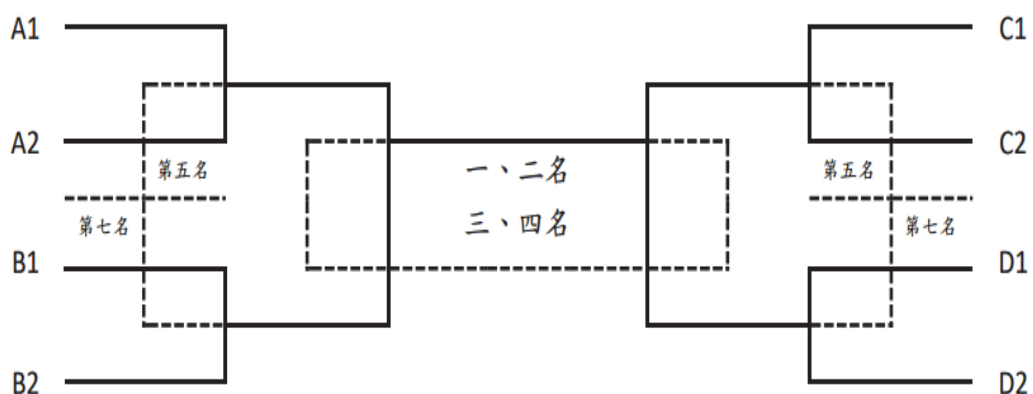
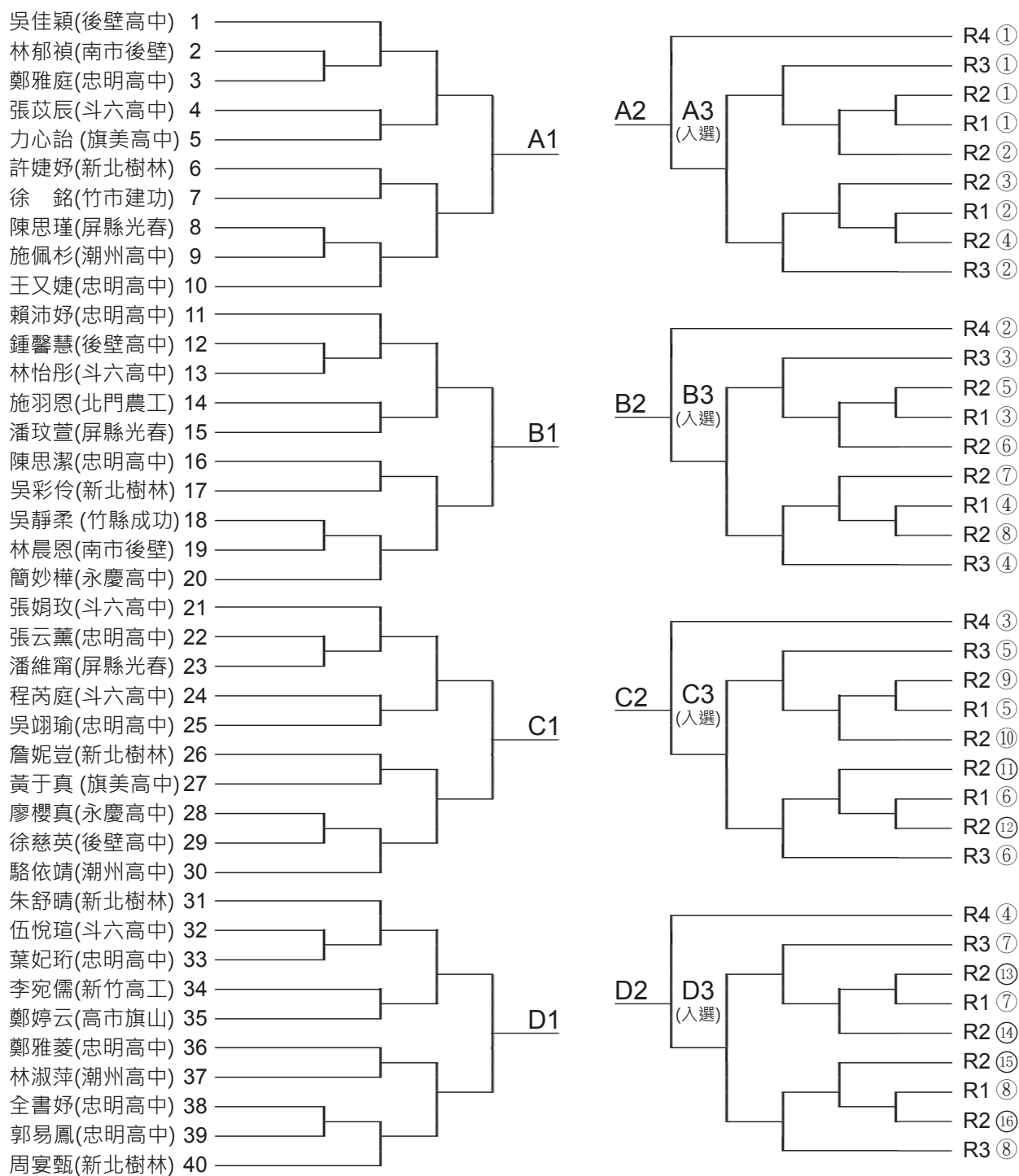

U21 男單

(八強前 5 局制) 取前 8 名

落入敗部後，隨即由大會公開抽籤決定號位

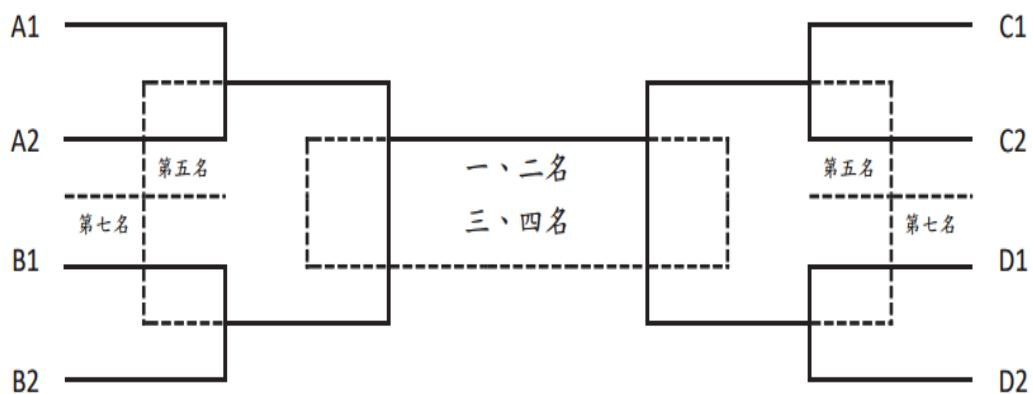
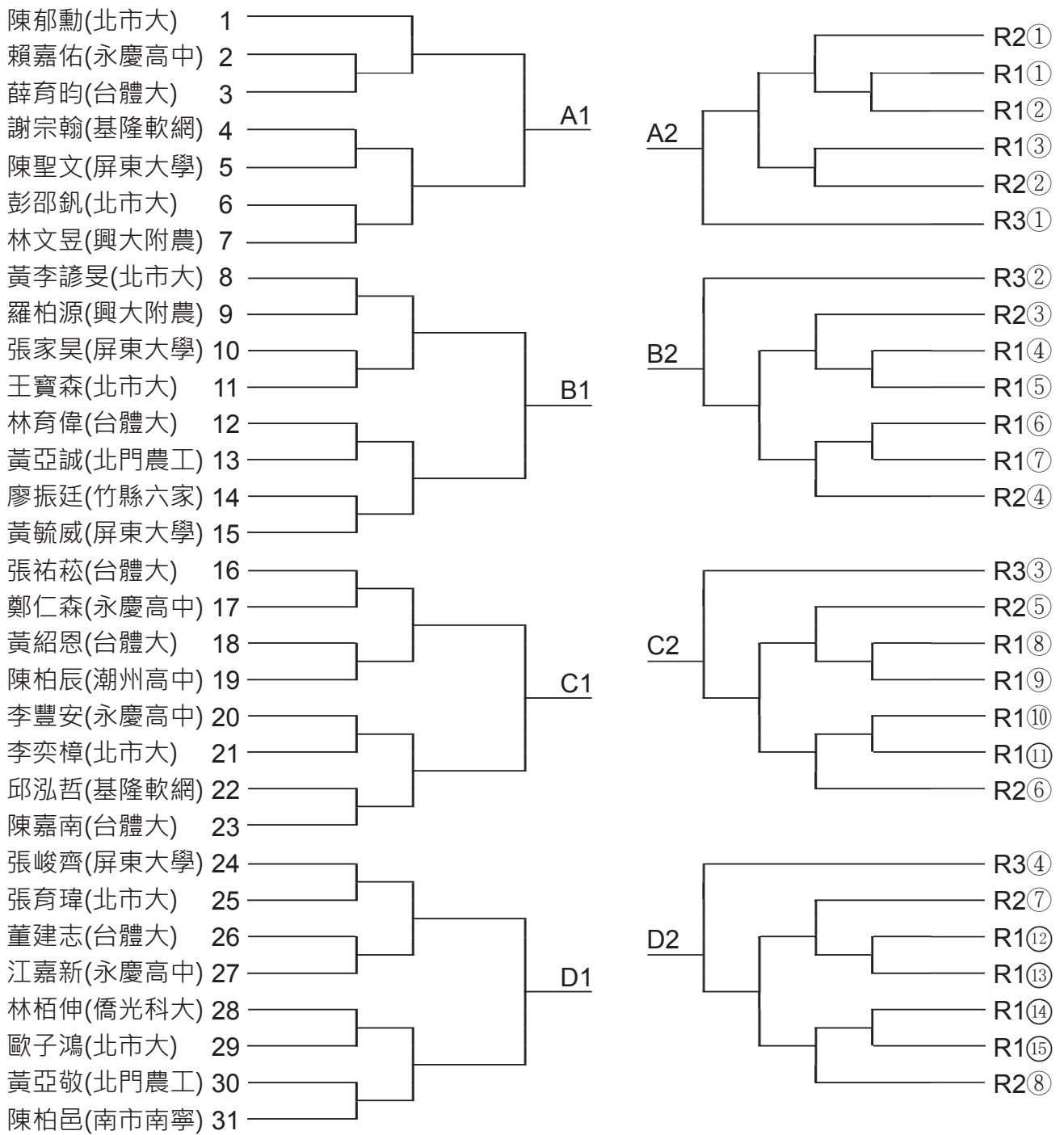

U21 女單

(7局制) 取前4名

落入敗部後，隨即由大會公開抽籤決定號位

